

# MH 3M - MH 4M MH 5M - MH 6P - MH 7P

## Instructions for use

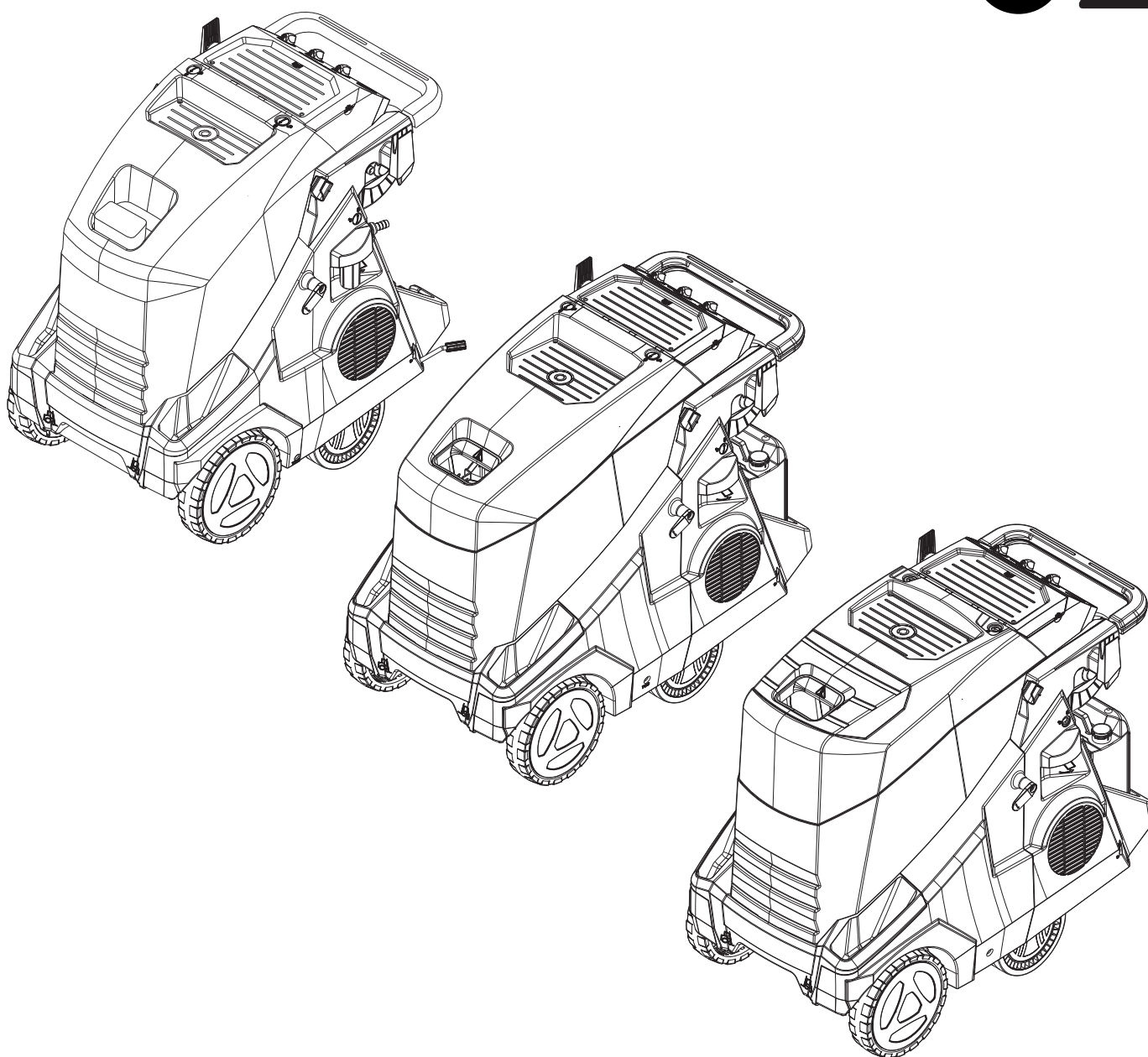

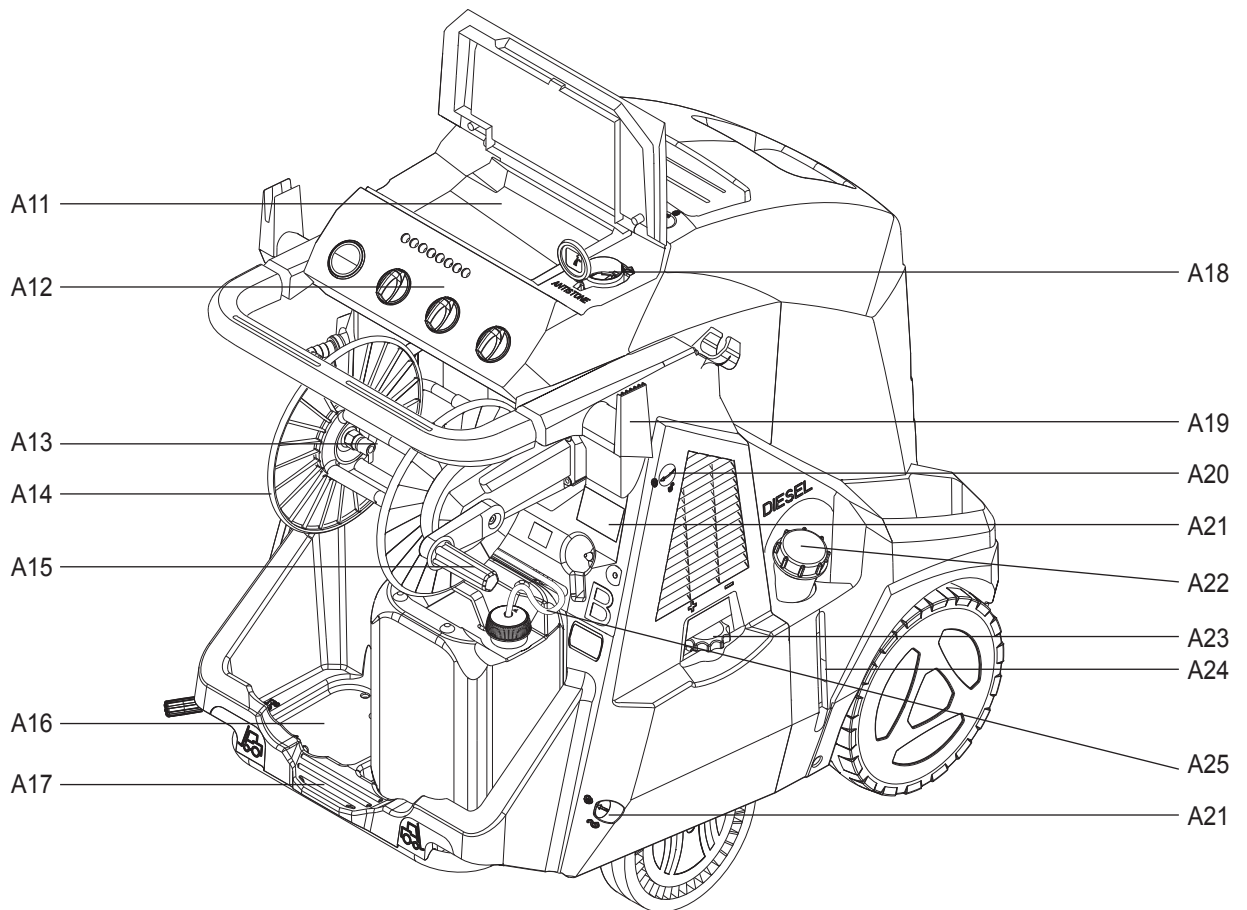
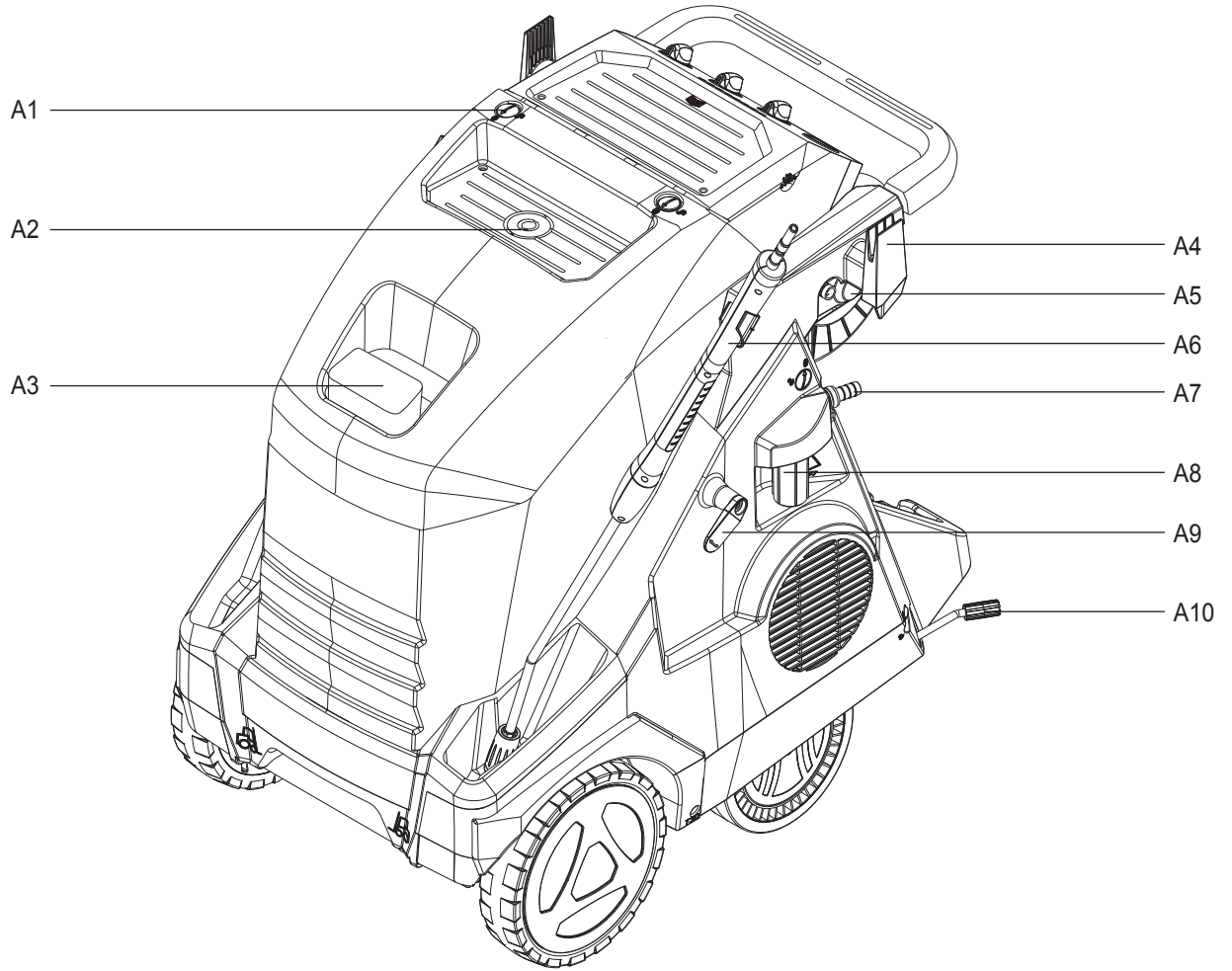

**A**

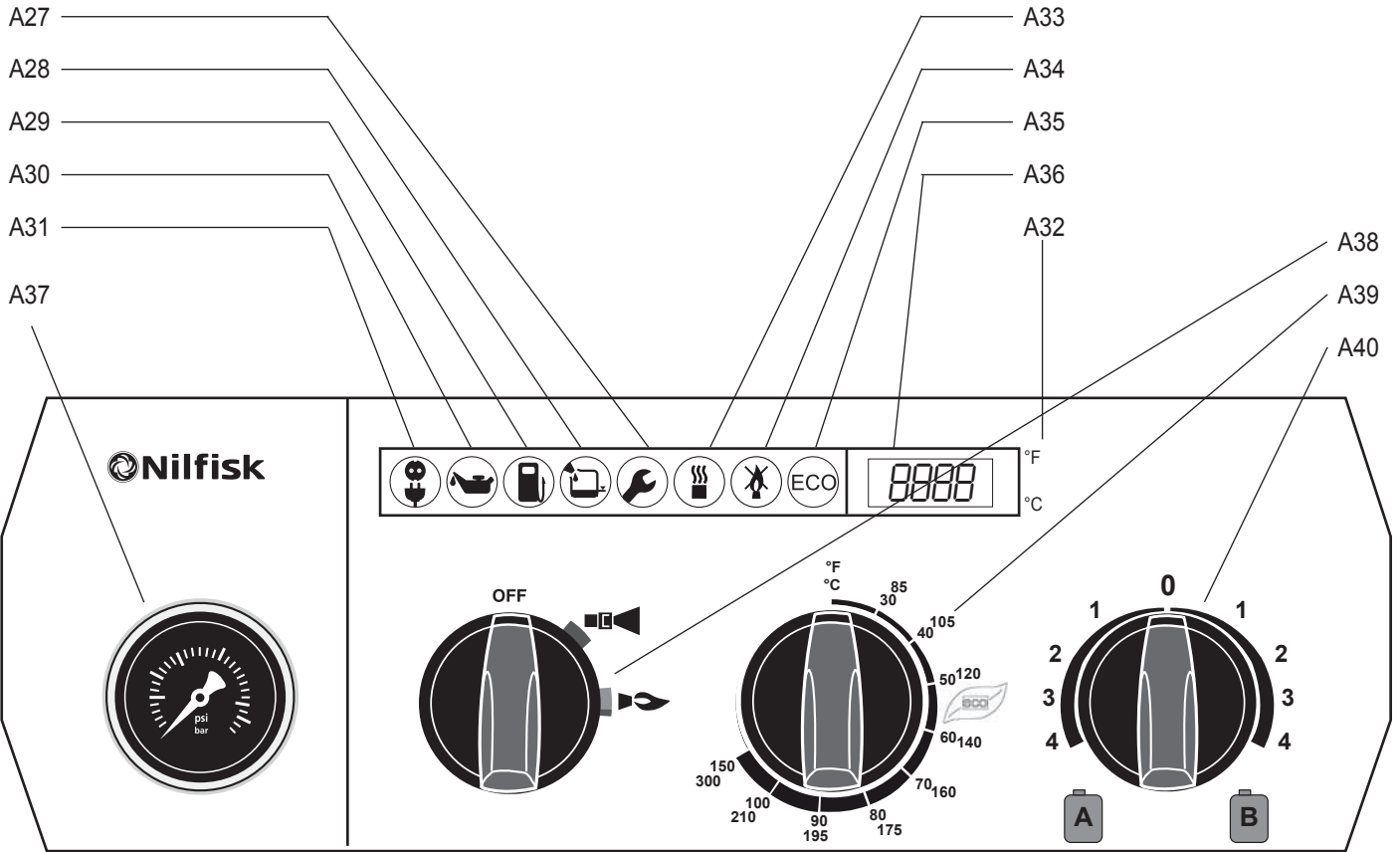

**B**

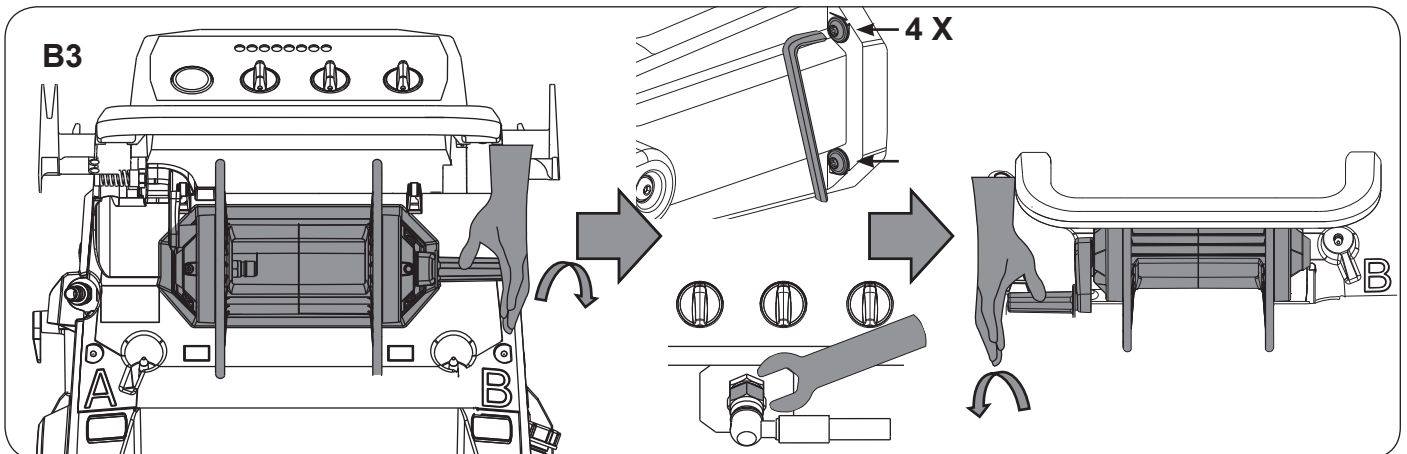
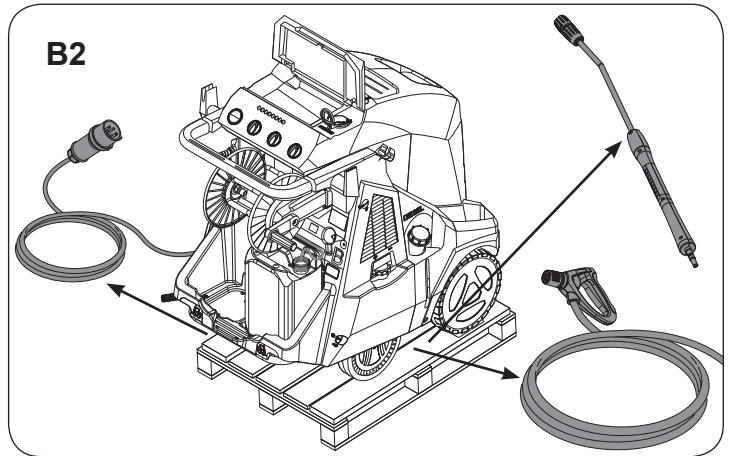
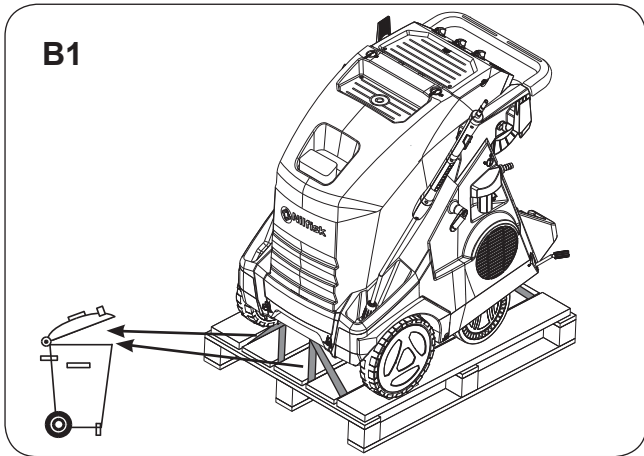

B4.a

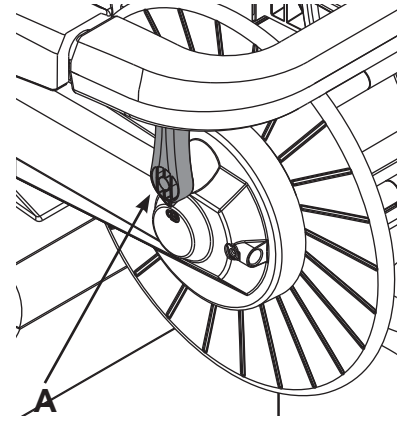
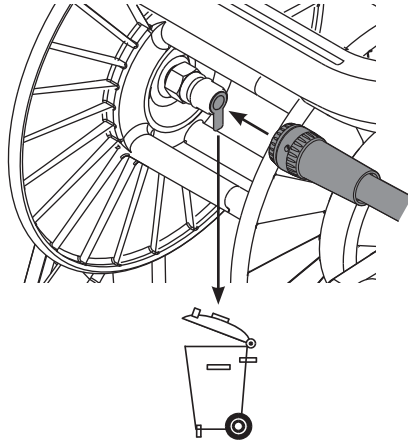
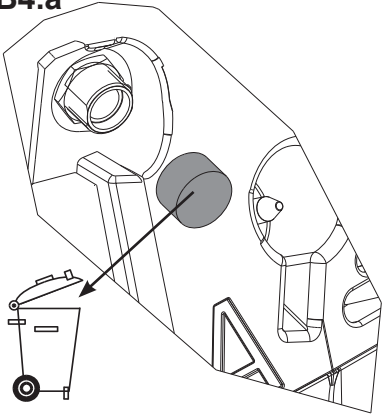

B4.b

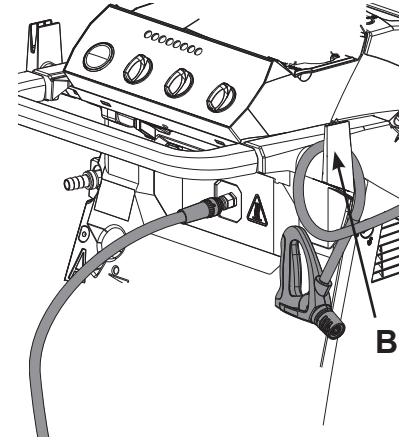
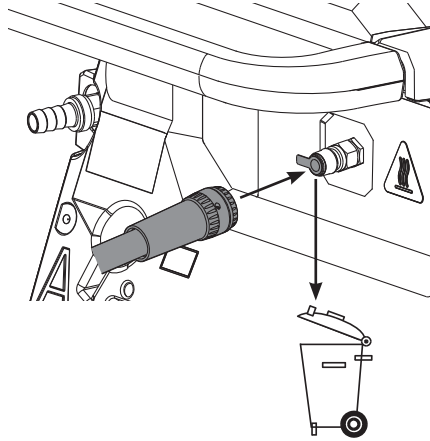
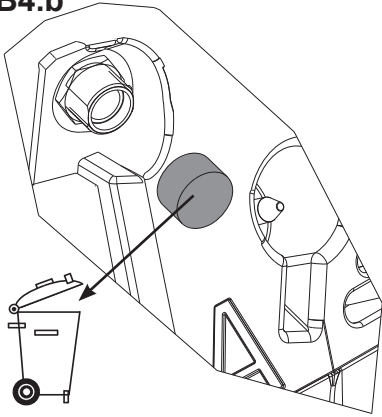

B5

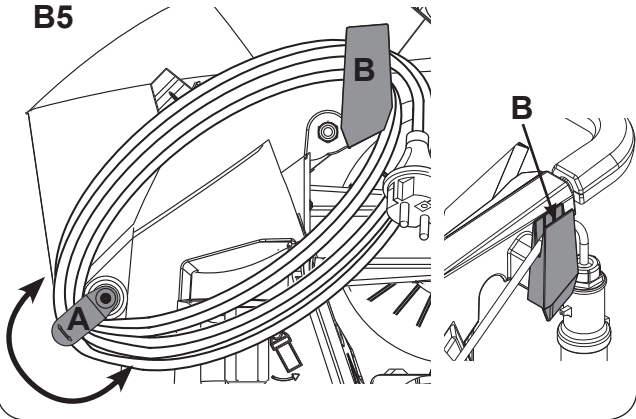

B6

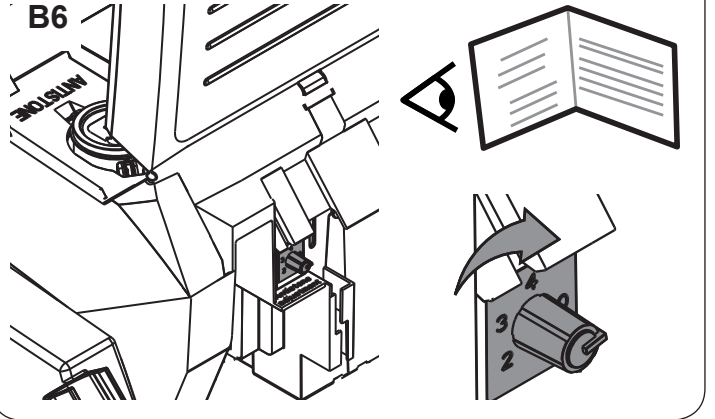

B

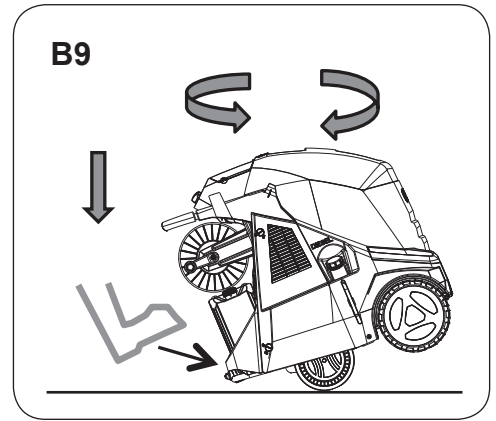
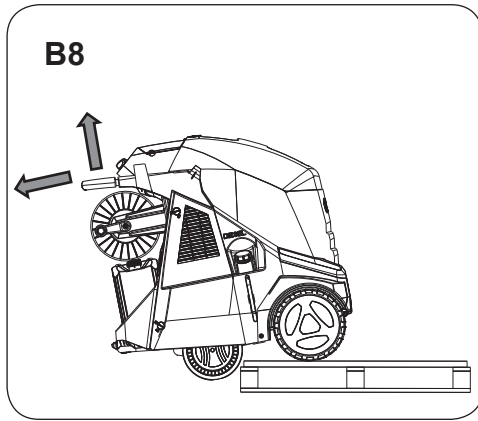
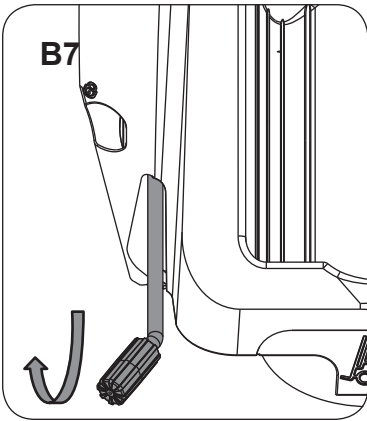

C

**C1.a**

**C1.b**

**C1.c**

C

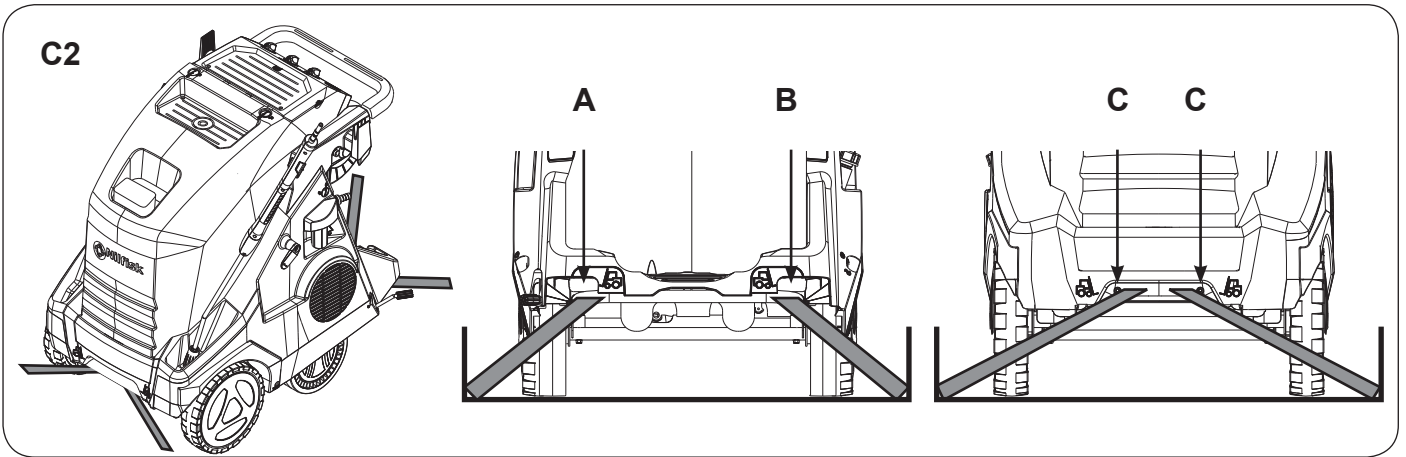

D

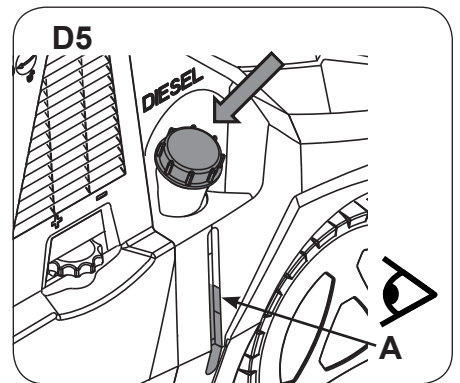
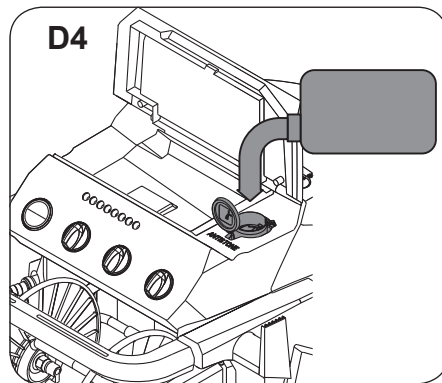
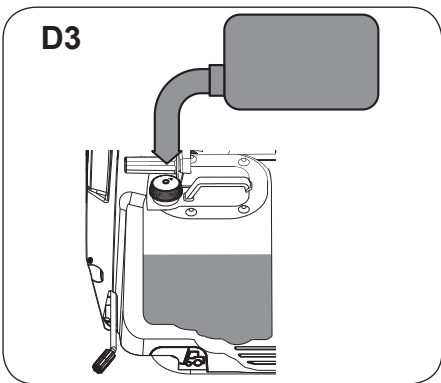
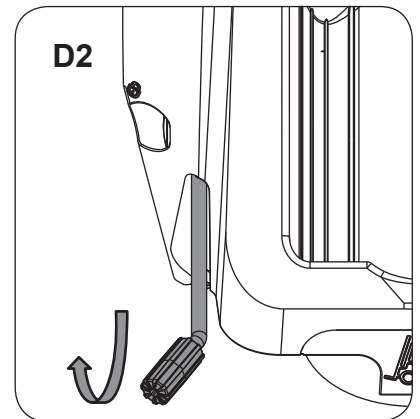
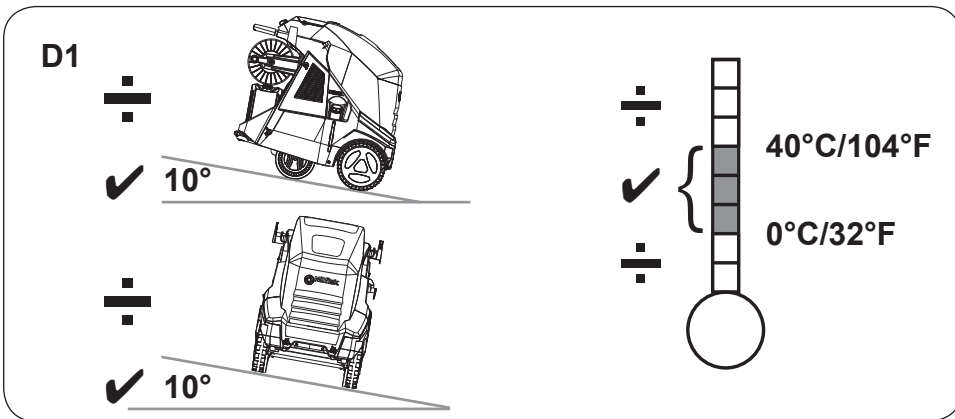

E

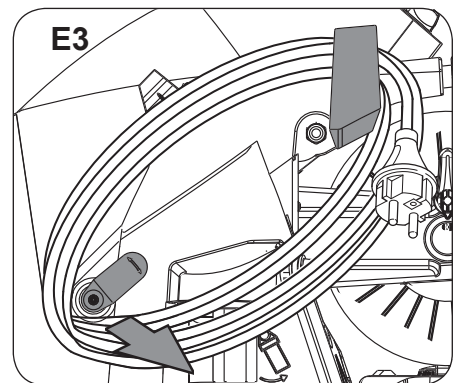
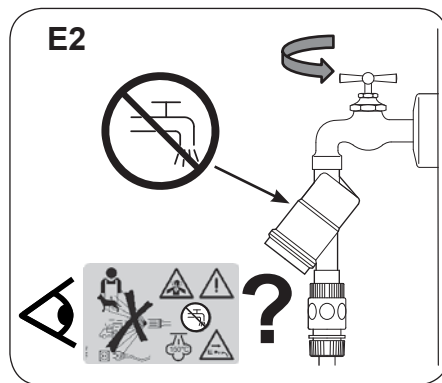
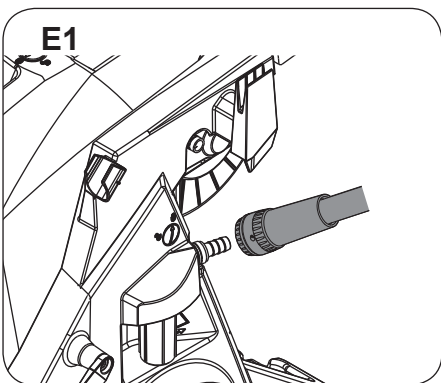

E4

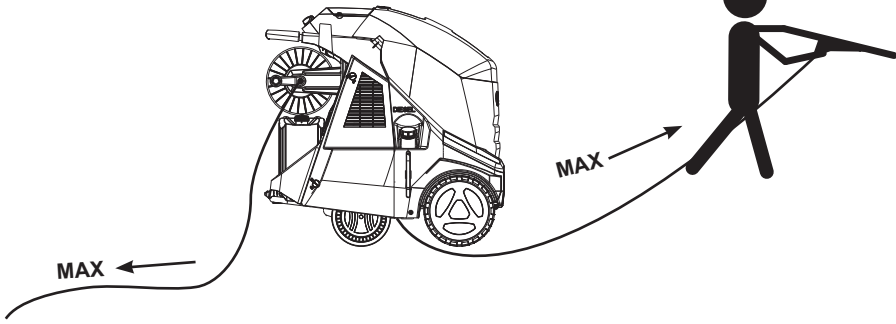

E5

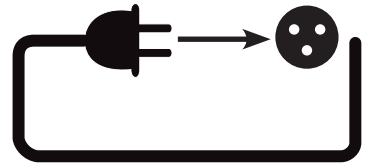

E6

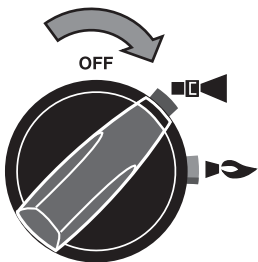

E7

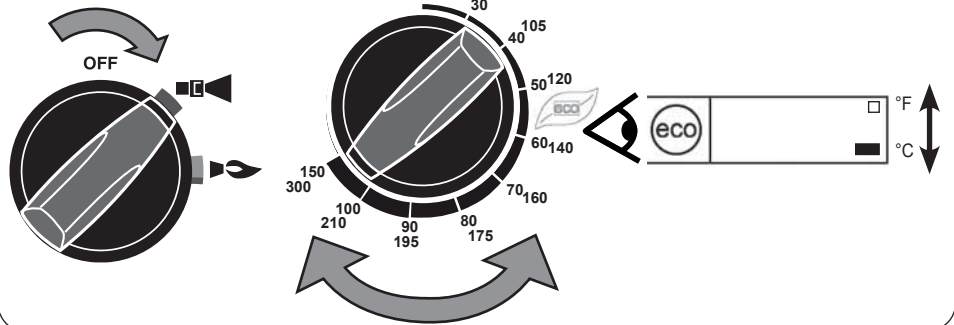

E8

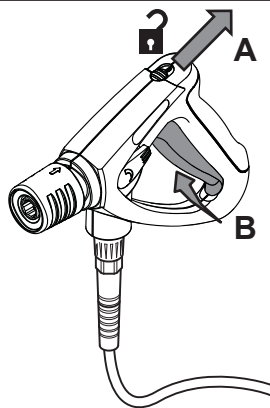
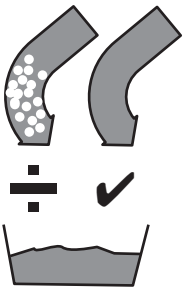

E9

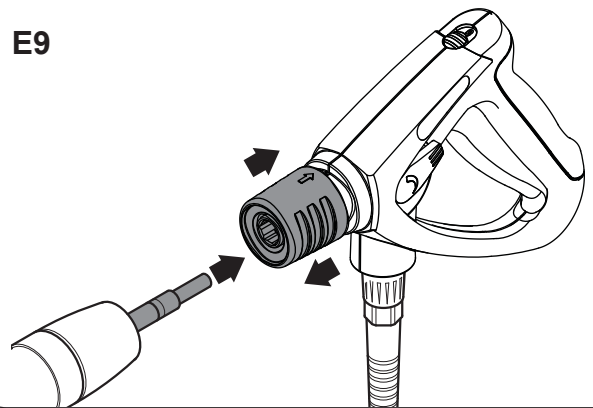

E10.a

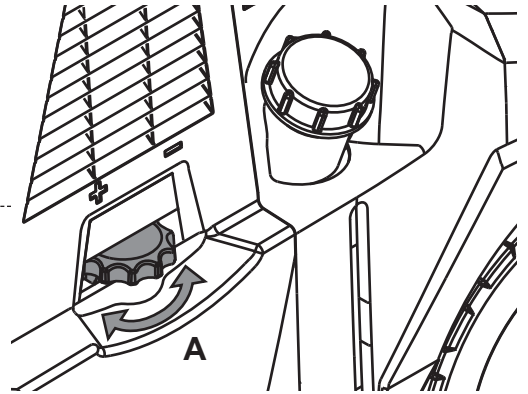
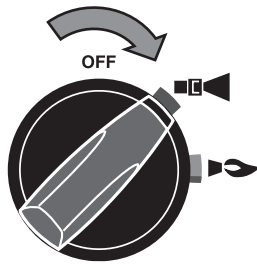

E10.b



Max 100°C/210°F

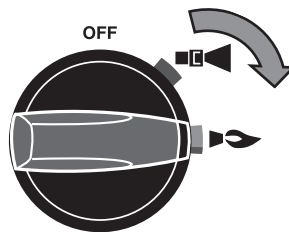
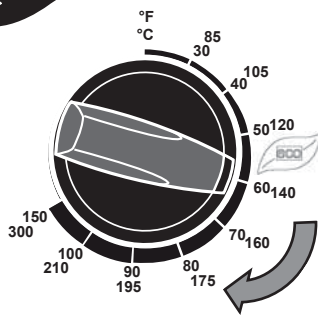

E10.c

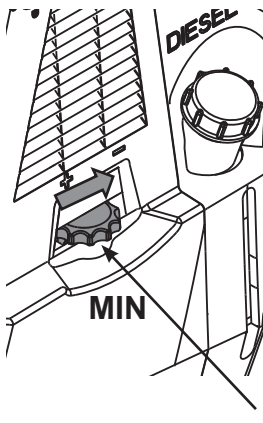
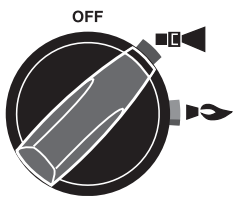

Max 32 bar

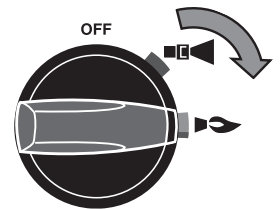
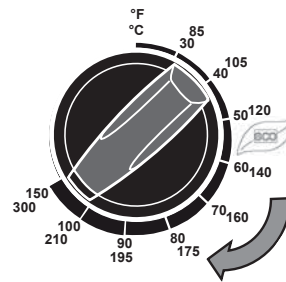



E11

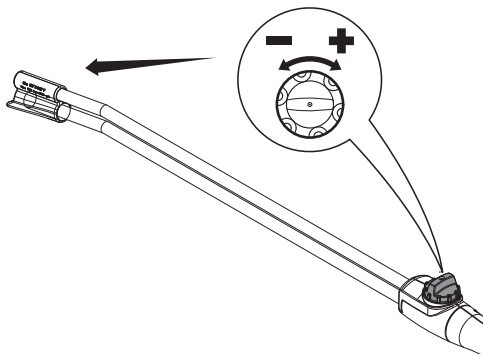
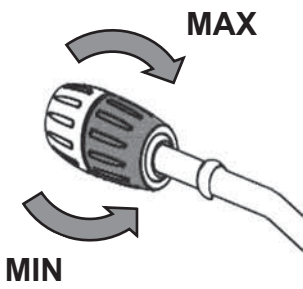
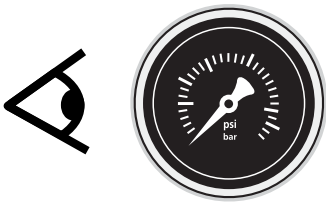

E12

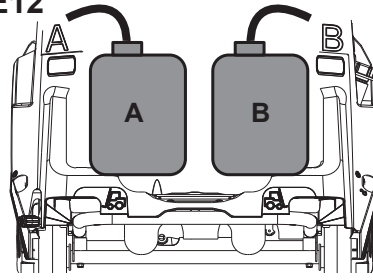

E12.b

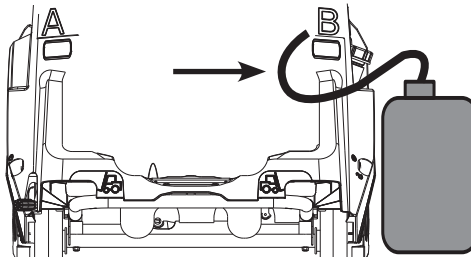

E12.c

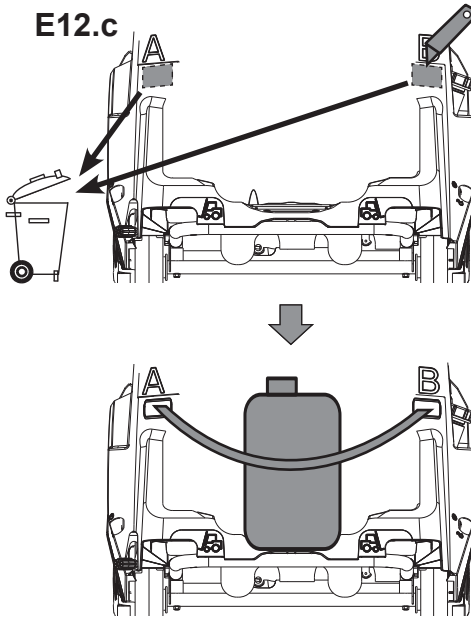

E13

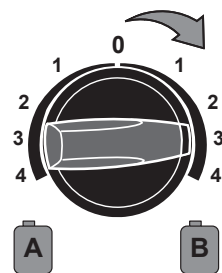
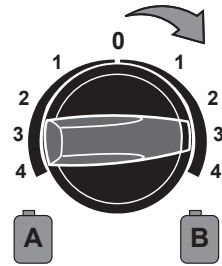
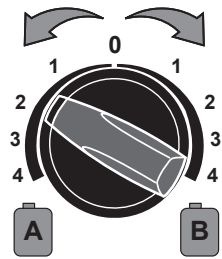

F1

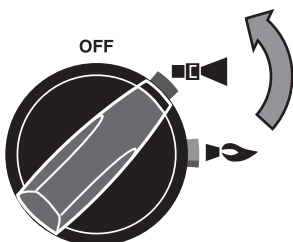

F2

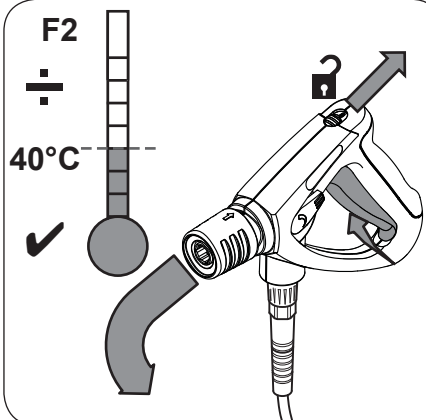

F3

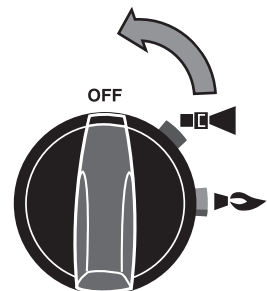

F

F4

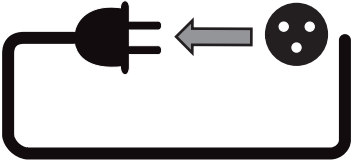

F5

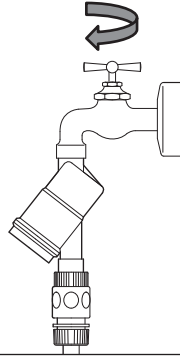

F6

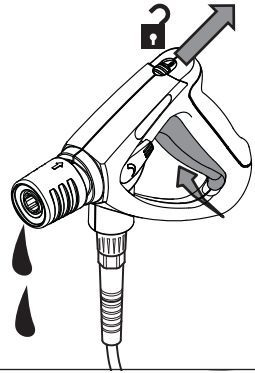

F7

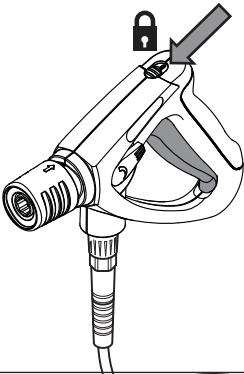

G

G1

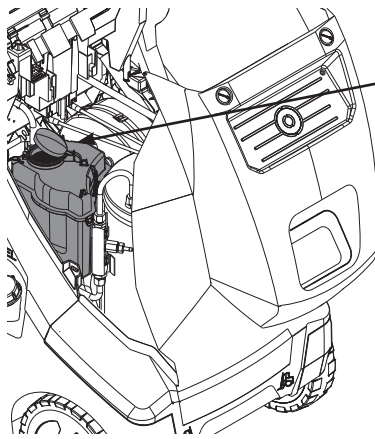
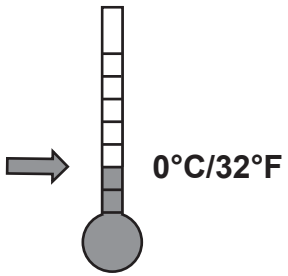

C

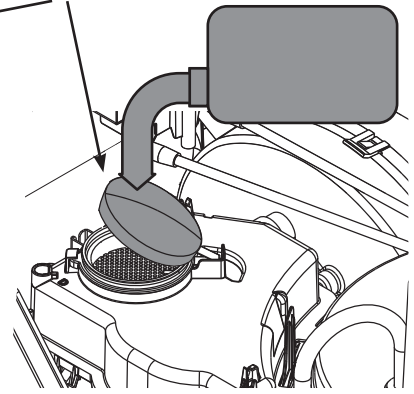

G2

B

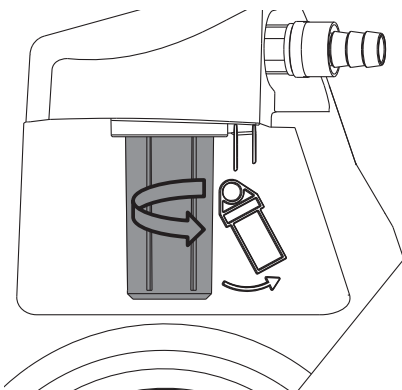

C

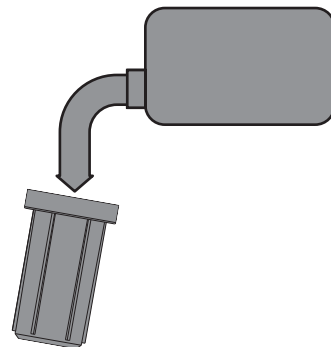

H1.a

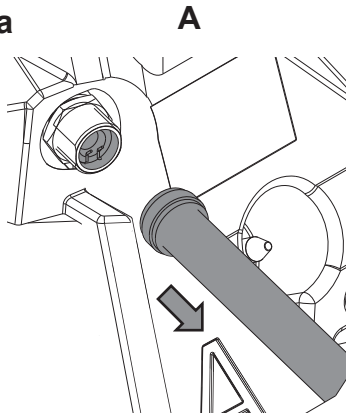

**B**

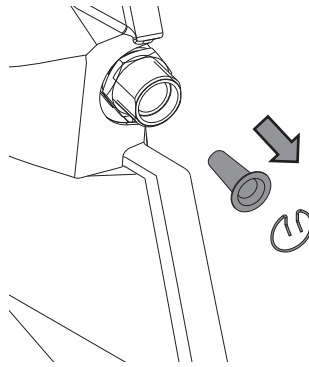

**C**

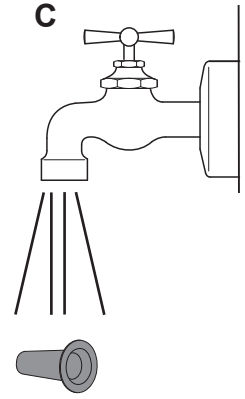

H1.b

**A**

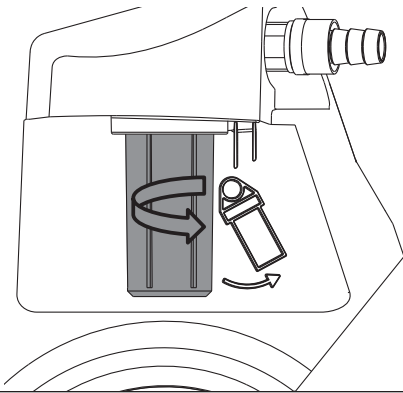

**B**

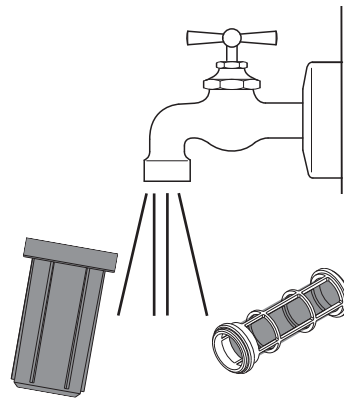

H2

**A**

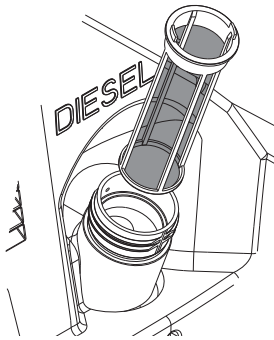

**B**

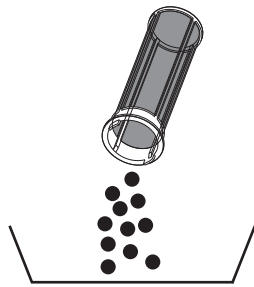

H3

**A**

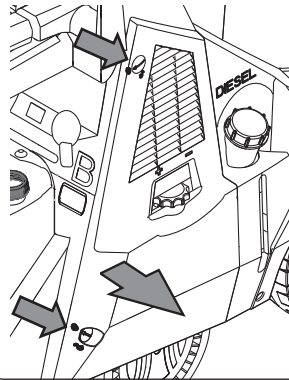

**B**

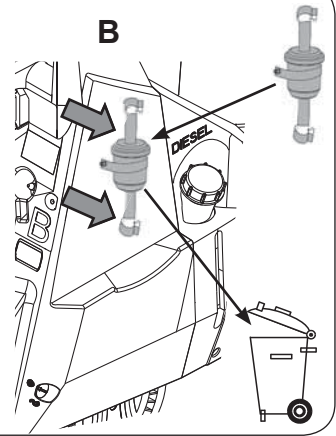

H4

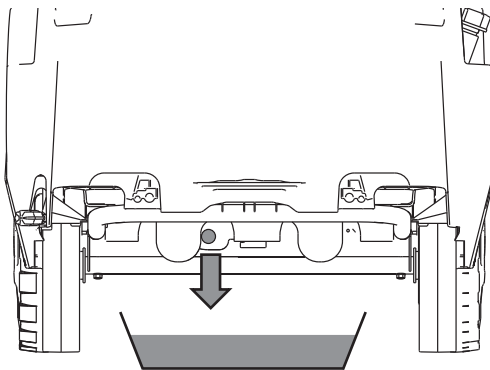

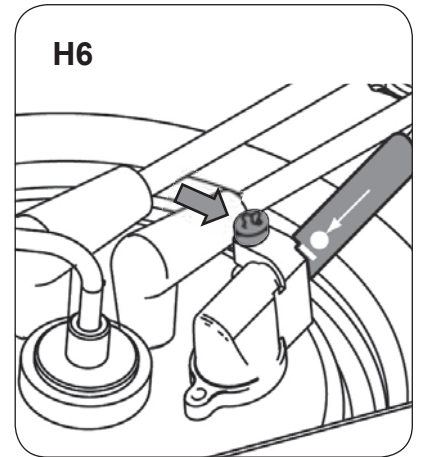
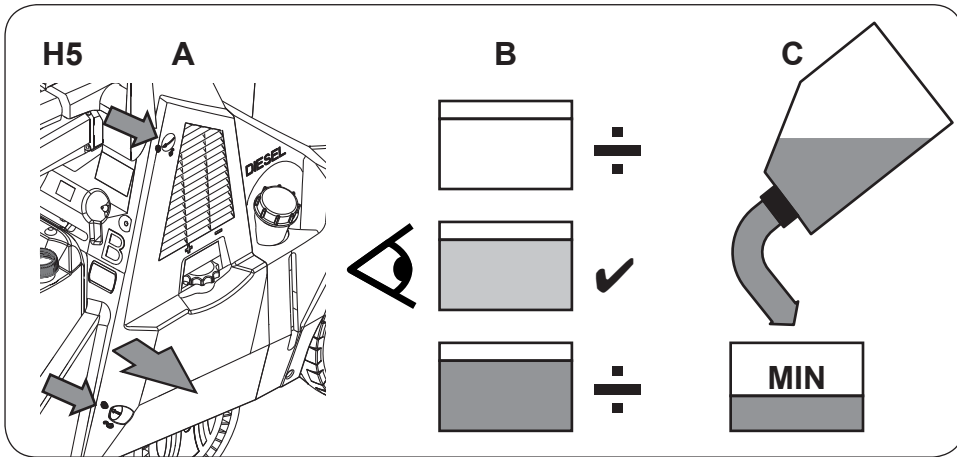

|           |                                       |     |
|-----------|---------------------------------------|-----|
| <b>EN</b> | Operating instructions .....          | 14  |
| <b>DE</b> | Bedienungsanweisungen .....           | 18  |
| <b>FR</b> | Instructions de fonctionnement .....  | 22  |
| <b>NL</b> | Gebruiksaanwijzingen .....            | 26  |
| <b>IT</b> | Istruzioni per l'uso .....            | 30  |
| <b>NO</b> | Bruksanvisning .....                  | 34  |
| <b>SV</b> | Bruksanvisning .....                  | 38  |
| <b>DA</b> | Betjeningsvejledning .....            | 42  |
| <b>FI</b> | Käyttöohje .....                      | 46  |
| <b>ES</b> | Instrucciones de funcionamiento ..... | 50  |
| <b>PT</b> | Instruções de Funcionamento .....     | 54  |
| <b>EL</b> | Οδηγίες λειτουργίας .....             | 58  |
| <b>TR</b> | Kullanma Talimatları .....            | 63  |
| <b>SL</b> | Navodila za delovanje .....           | 68  |
| <b>HR</b> | Upute za uporabu .....                | 72  |
| <b>SK</b> | Návod na obsluhu .....                | 76  |
| <b>CS</b> | Návod k obsluze .....                 | 80  |
| <b>PL</b> | Instrukcje dotyczące obsługi .....    | 84  |
| <b>HU</b> | Használati útmutató .....             | 88  |
| <b>RO</b> | Instrucțiuni de utilizare.....        | 92  |
| <b>BG</b> | Указания за експлоатация .....        | 96  |
| <b>RU</b> | Руководство по эксплуатации .....     | 101 |
| <b>ET</b> | Tööjuhised .....                      | 106 |
| <b>LV</b> | Norādījumi par ekspluatāciju .....    | 110 |
| <b>LT</b> | Naudojimo instrukcija .....           | 114 |
| <b>JA</b> | 作手順.....                              | 118 |
| <b>ZH</b> | 操作说明.....                             | 122 |
| <b>KO</b> | 사용법.....                              | 126 |
| <b>TH</b> | คำแนะนำการใช้งาน.....                 | 130 |
| <b>MS</b> | Arahan Operasi .....                  | 134 |

# Betriebsanleitung

Dieser Hochdruckreiniger ist für den professionellen Einsatz vor allem in den folgenden Anwendungsbereichen bestimmt: Landwirtschaft, Industrie, Transport, Kraftfahrzeugreinigung, kommunale Einrichtungen, Reinigungsgewerbe, Bauindustrie, Nahrungsmittelindustrie usw.

## Illustrierte Kurzanleitung

Die illustrierte Kurzanleitung soll Sie bei Inbetriebnahme, Benutzung und Lagerung des Geräts unterstützen. Die Anleitung ist in acht Abschnitte gegliedert.

### A

#### Vorbereitung

#### LESEN SIE BITTE VOR DER BENUTZUNG DIE SICHERHEITSHINWEISE!

##### Bedienelemente:

- A1. Deckelöffner
- A2. Aufnahme für Service-Kran und Hebering<sup>1)</sup>
- A3. Hießluftauslass
- A4. Kabelverschluss
- A5. Hochdruck-Schlauchtrommel-Verschluss<sup>1)</sup>
- A6. Sprühhrohr
- A7. Wasseranschluss
- A8. Wassereinflussfilter<sup>1)</sup>
- A9. Verstellbarer Kabelverschluss
- A10. Feststellbremse
- A11. Werkzeugkasten
- A12. Bedienfeld
- A13. Hochdruck-Schlauchanschluss am Gerät B4.a/B4.b<sup>1)</sup>
- A14. Hochdruck-Schlauchtrommel<sup>1)</sup>
- A15. Hebelgriff für Hochdruck-Schlauchtrommel<sup>1)</sup>
- A16. Reinigungskanisteraufnahme
- A17. Fußbrett zum Neigen des Geräts
- A18. Tanköffnung für Nilfisk AntiStone
- A19. Hochdruckschlauch-Verschluss
- A20. Seitentürgriff
- A21. Sicherheitsetikett
- A22. Kraftstofftanköffnung
- A23. Sprühpistolenhalter
- A24. Wassermengenregler<sup>1)</sup>
- A25. Kraftstoffstand-Anzeige
- A26. Langer Reinigungsmittelschlauch für externen Kanister
- A27. Service-Intervall fällig/überschritten LED
- A28. Nilfisk AntiStone niedrig<sup>1)</sup> LED
- A29. Kraftstoff niedrig<sup>1)</sup> LED
- A30. Pumpenölstand niedrig<sup>1)</sup> LED
- A31. Hauptschalter EIN LED
- A32. Fahrenheit /Celsius Anzeiger<sup>1)</sup>
- A33. Erhitzer überhitzt LED
- A34. Keine Flamme LED
- A35. ÖKO-Modus LED
- A36. Stundenzähler; Solltemperaturanzeige; Fehlercodes<sup>1)</sup>
- A37. Druckanzeige<sup>1)</sup>
- A38. Hauptschalter mit Kalt-/Heißwasserauswahl
- A39. Knopf zur Temperaturreglersteuerung
- A40. Messknopf für Reinigungsmittel<sup>1)</sup>

### B

#### Auspacken und Vorbereiten des Geräts

- B1. Transportschutz vom Gerät entfernen.
- B2. Schlauch, Sprühhrohr und Kabel von der Palette entnehmen.

- B3. Bei Bedarf kann die Schlauchtrommel von Rechtshand- und Linkshandbedienung umgestellt werden<sup>1)</sup>.
- B4.a Modelle mit Schlauchtrommel: Transportkappen von Ein- und Auslass entfernen. Hochdruckschlauch anschließen, auf der Schlauchtrommel aufrollen und die Schlauchtrommel am Griff (A) befestigen<sup>1)</sup>.
- B4.b Modelle ohne Schlauchtrommel: Transportkappen von Ein- und Auslass entfernen. Hochdruckschlauch anschließen und auf dem Haken (B) platzieren.
- B5. Stromkabel um den Kabelverschluss (A und B) wickeln und das Kabelende am Verschluss (B) befestigen.
- B6. Das Nilfisk Antiscale Gerät ist ab Werk auf eine mittelharte Wasserhärte eingestellt. Siehe Tabelle im Abschnitt Wartung. Bei Einstellung auf „0“ wird die Warmmeldung verworfen.
- B7. Radbremse lösen.
- B8. Hebel anheben und das Hinterrad des Reinigers von der Palette auf den Boden ziehen.
- B9. Zum einfachen Neigen und Manövrieren auf das Fußbrett treten und den Hebel nach unten drücken.

### C

#### Heben und Verzurren zum Transport

- C1.a Die sicherste Methode zum Heben des Reinigers ist die Nutzung eines Gabelstaplers am vorderen oder hinteren Ende des Reinigers. (Nicht von der Seite!).
- C1.b Beim Anheben mit Gurten die Hebepunkte (A,B,C) verwenden. Die Gurte nicht an den Kunststoffteilen des Geräts befestigen, da diese sich vom Rahmen lösen könnten.
- C1.c Wird das Gerät regelmäßig gehoben, wird der Nilfisk Hebesatz (#107140912 + #301001090) empfohlen.
- C2. Zum Fixieren mithilfe von Gurten für den Transport die Hebepunkte (A,B,C) verwenden. Die Gurte nicht an den Kunststoffteilen befestigen, da diese sich vom Rahmen lösen könnten.

### D

#### Einrichten des Geräts:

Befindet sich Ihr Standort mehr als 500 m über dem Meeresspiegel, muss der Brenner eventuell für eine optimale Leistung und Kraftstoffeffizienz neu eingestellt werden. Wenden Sie sich an den Nilfisk Service. Bei Standorten mit einer Höhe von 1000 bis 2500 m über dem Meeresspiegel ist eventuell der optionale Brennersatz erforderlich. Wenden Sie sich an den Nilfisk Service.





Vor dem ersten Einsatz des Reinigers gründlich auf Fehler oder Schäden prüfen. Das Gerät nur in einem einwandfreien Zustand betreiben.

- D1. Die Neigung des Untergrundes für den Hochdruckreiniger darf zu keiner Seite 10° übersteigen.  
OBS: die Umgebungstemperatur muss zwischen 0°C und 40°C liegen.
- D2. Bremse betätigen.
- D3. Reinigungsbehälter füllen<sup>1)</sup>.
- D4. Behälter für Nilfisk AntiStone füllen<sup>1)</sup>.
- D5. Kraftstofftank mit frischem Kraftstoff, Heizöl, DIN 51603-1 (Ohne Bio-Diesel) befüllen. Diesel gemäß DIN EN 590 (bis zu 7% Bio-Diesel) darf bei über 0°C Umgebungstemperatur unter folgenden Einschränkungen eingesetzt werden: Maximale Lagerdauer im Kraftstoffbehälter des Hochdruckreinigers: 1 Monat. Diesel, das älter als 6 Monate ist, darf nicht eingesetzt werden. Diesel nach DIN EN 590 aus einem offenen Behälter darf nicht eingesetzt werden.  
Kraftstoffanzeiger (A) unter der Füllöffnung beachten.

## E

**Einschalten des Geräts**

OBS: Das Gerät ist möglicherweise ab Werk mit Frostschutzmittel ausgestattet<sup>1)</sup> - Punkt E8 unten beachten.

- E1. Wasserversorgung anschließen.
- E2. Steht auf dem Sicherheitsetikett das Symbol , ist ein Rückflussventil erforderlich.
- E3. Kabelverschluss ziehen und das Kabel ausziehen.
- E4. Schlauch und Kabel vor Nutzung vollständig ausrollen.
- E5. Stromversorgung anschließen.
- E6. Einschalten des Reinigers. Kaltwasserbetrieb.
- E7. Fahrenheit /Celsius einstellen: (A) neben dem Ein-/Aus-schalter in den Kaltmodus stellen und (B) die Temperatursteuerung auf max drehen<sup>1)</sup>.
- E8. Sicherheitsverschluss lösen und das Gerät durch Betätigen der Sprühpistole entlüften.  
Befindet sich Frostschutzmittel im Reiniger, sammeln Sie die ersten 5 Liter der Flüssigkeit zur späteren Nutzung in einem Behälter. Bei gleichmäßigem Wasserfluss mit den folgenden Schritten fortfahren.
- E9. Sprührohr an die Sprühpistole anschließen.
- E10.a Kaltwassermodus.  
Reiniger auf  schalten.  
Die Flusssteuerung wird am Pumpengriff (A) eingestellt.
- E10.b Warmwassermodus (bis zu 100°C)  
Temperatur wählen, ÖKO-Modus Einstellung für optimale Standard-Reinigung. Reiniger auf  schalten.  
Die Flusssteuerung wird am Pumpengriff (A) eingestellt.
- E10.c Dampfmodus<sup>1)</sup> (über 100°C)  
Flusssteuerung<sup>1)</sup> (A) vollständig bis zum rechten Stopp aufdrehen  
(OBS: max. 32 bar bei Temperaturen über 100°C!).  
Temperatur über 100°C wählen.  
Reiniger auf  schalten.
- E11. Druckregelung mit FlexoPower oder Tornado Sprührohr<sup>1)</sup>.
- E12.a Ansaugen aus internem Reinigungsmittelbehälter.  
Gewünschte Konzentration von Reinigungsmittel (A) oder (B) am Dosierknopf einstellen<sup>1)</sup>.
- E12.b Ansaugen aus internem Reinigungsmittelbehälter:  
Schlauch (B) aus dem Gerät ziehen und am Behälter anschließen. Gewünschte Konzentration von Reinigungsmittel (B) am Dosierknopf einstellen<sup>1)</sup>.
- E12.c Ansaugen aus 25 L Behälter: (nur für Version ohne Schlauchtrommel). Den markierten Bereich mit einem Messer entfernen, um die Befestigungspunkte freizulegen. Behälter an der Rückseite des Geräts befestigen. Schlauch (B) aus dem Gerät ziehen und am Behälter anschließen.
- E13. Reinigungsmittel einsetzen: Gewünschte Konzentration von Reinigungsmittel (A) oder (B) am Dosierknopf einstellen<sup>1)</sup>. Objekt besprühen. Reinigungsmittel je nach Grad der Verschmutzung wirken lassen. Anschließend mit Hochdruckstrahl absprühen. Reinigungsmittel niemals auf dem Objekt trocknen lassen, da ansonsten die Oberfläche angegriffen werden kann.

## F

**Nach dem Einsatz des Geräts und vor der Lagerung**

- F1. In den Kaltmodus schalten.
- F2. Im Kaltmodus betreiben, um das Gerät abzukühlen.
- F3. Reiniger abschalten. Schalter in Stellung „OFF“ stellen.
- F4. Versorgungsleitungen vom Gerät trennen.
- F5. Wasserhahn schließen.
- F6. Sprühpistole drücken, um den Druck abzulassen.
- F7. Die Sicherheitssperre am Sprühgriff verriegeln.

## G

































- G1. **Lagerung des Reinigers bei unter 0°C:**  
Wasserezulaufschlauch vom Reiniger entfernen. Sprührohr entfernen. Reiniger mit Hauptschalter in Stellung „Kaltwasser“ einschalten. Die Sprühpistole betätigen. Langsam Frostschutzmittel (etwa 5 Liter) in den Wasserbehälter (C) füllen. Das Gerät ist frostsicher, wenn das Frostschutzmittel aus der Sprühpistole austritt. Die Sicherheitssperre am Sprühgriff verriegeln. Gerät ausschalten Zur Vermeidung von Schäden das Reinigungsgerät vor der nächsten Inbetriebnahme zunächst in einem beheizten Raum zwischengelagern. Bei der erneuten Inbetriebnahme des Geräts kann das Frostschutzmittel gesammelt und erneut verwendet werden.
- G2. Filterglas neigen und abschrauben,<sup>1)</sup> entleeren, mit Frostschutzmittel auffüllen und wieder am Reiniger anbringen.

## H

**Wartung und Fehlerbehebung**



- H1.a Wassereinfluss - Fingerfilter<sup>1)</sup>: Schlauchtülle entfernen. Verschluss und Filter entfernen und mit Wasser reinigen.
- H1.b Wassereinfluss – großer Filter<sup>1)</sup>: Glas nach außen neigen, abschrauben und mit Wasser reinigen.
- H2. Kraftstoff-Füllfilter: Der Filter kann mit den Fingern entfernt und mit sauberem Kraftstoff gespült werden.
- H3. Kraftstofffilter: Für Zugriff die Seitenklappe (A) öffnen. Schlauchklemmen öffnen und Kraftstofffilter (B) ersetzen. Die geltenden Vorschriften zur Entsorgung beachten. Für Ersatzfilter bitte an Nilfisk wenden.
- H4. Kraftstofftank: Ablassschraube entfernen und Kraftstoff in einen leeren Behälter ablassen. Mit sauberem Kraftstoff spülen. Die geltenden Vorschriften zur Entsorgung beachten.
- H5. Pumpenöl: Qualität des Pumpenöls prüfen: Farbe des Pumpenöls prüfen. Ist das Öl dunkelgrau oder weißlich gefärbt, an den Nilfisk Service wenden!  
Die kalte Pumpe mit frischem Öl bis zur Markierung MAX auffüllen, falls erforderlich.
- H6. Flammensensor<sup>1)</sup>: Sensor entfernen und mit einem weichen Tuch reinigen. Sicherstellen, dass der Sensor nach dem Wiedereinsetzen korrekt montiert wurde. Die Symbole müssen nach oben zeigen.

## Anzeigen am Bedienfeld

| Anzeigeleuchten   | Anzeige <sup>1)</sup> | Ursache  | Abhilfe  |
|---|-----------------------|--|--|
|  Dauerlicht  | 0024                  | - Gerät betriebsbereit.<br>- Beim Einschalten in den Kaltmodus wird der Stundenzähler einige Sekunden lang eingeblendet.   |  |
|  Blinklicht  |                       | - Wasserhahn geschlossen oder geringe Wassermenge.<br>- Reinigungsbehälter ist leer.<br>- Druckregler der Sicherheitssteuerung sperrt oder die VarioPress <sup>1)</sup> Lanze ist auf geringe Wassermenge eingestellt.<br>- Gerät verkalkt | - Wasserversorgung überprüfen.<br>- Reinigungsmittel nachfüllen oder den Schalter für Reinigungsmittel auf „0“ stellen.<br>- Einstellung der Sicherheitssteuerung/VarioPress ändern, um vollen Wasserdurchfluss zu ermöglichen.<br>-  Nilfisk Service. |
|  Blinklicht  | FLO                   | - Das Gerät läuft seit über 120 Sekunden ohne ausreichende Wasserversorgung. Das Gerät schaltet ab, um ein Überhitzen der Pumpe zu vermeiden.  | - Falls der Fehler weiterhin auftritt, das Gerät neu starten<br> Nilfisk Service.  |
|  Dauerlicht  | FUE                   | - Nur noch wenig Brennstoff.<br>- Betrieb mit Kaltwasser möglich.  | - Brennstoffstand überprüfen und nachfüllen, nach 5 Sekunden Fehler zurücksetzen.  |
|  Dauerlicht  |                       | - Füllstand Nilfisk AntiStone niedrig <sup>1)</sup> .<br>- Das Gerät kann weiterhin betrieben werden.  | - Füllstand Nilfisk AntiStone überprüfen und nachfüllen.   |
|  Dauerlicht  Dauerlicht     |                       | - Service-Intervall überschritten.<br>- Das Gerät kann weiterhin betrieben werden.   | -  Nilfisk Service.  |
|  Dauerlicht  Blinklicht   |                       | - Service fällig nach 20 weiteren Betriebsstunden.<br>- Das Gerät kann weiterhin betrieben werden.   | -  Nilfisk Service.   |
|  Dauerlicht  | HOS                   | - Kessel ist überhitzt. Abgassensor (EXT-H) hat die Brennstoffzufuhr abgeschaltet.<br>- Gerät ist verkalkt.<br>- Kessel nicht gewartet.<br>- Betrieb mit Kaltwasser möglich.   | -  Nilfisk Service.  |
|  Dauerlicht  Dauerlicht | LHE                   | - Flammensensor (B7) ist verrußt.<br>- Fehler im Zünd- oder Brennstoffsystem.<br>- Betrieb mit Kaltwasser möglich.   | - Flammensensor (B7) reinigen.<br>-  Nilfisk Service.  |
|  Blinklicht  Blinklicht | LHL                   | - Kessel ist verrußt und benötigt Wartung.<br>- Kessel ist mit Diesel gefüllt.   | -  Nilfisk Service.  |
|  Dauerlicht  Dauerlicht | HOP                   | - Motor ist überhitzt.   | - Hauptschalter in Stellung „OFF“ bringen und Gerät abkühlen lassen.<br>- Verlängerungskabel entfernen/abziehen.<br>- Möglicher Phasenfehler.<br>- Den elektrischen Anschluss überprüfen lassen.<br>-  Nilfisk Service.                              |
|  Dauerlicht  Blinklicht | SEC                   | - Temperatursensor kurzgeschlossen.  | -  Nilfisk Service.  |
|  Blinklicht  | SEO                   | - Temperatursensor ist nicht angeschlossen.<br>- Betrieb mit Kaltwasser möglich.   |  |
|  Dauerlicht  Dauerlicht | FLF                   | - Fehlerhafter Durchflusssensor.   | -  Nilfisk Service.  |
|  Dauerlicht  | POL                   | - Niedriger Ölstand der Pumpe.<br>- Pumpe verliert Öl.   | - Füllstand des Öls überprüfen und nachfüllen.<br>-  Nilfisk Service.  |





## Weitere Störungen

| Störung  | Ursache   | Behebung   |
|--|---|--|
|  leuchtet nicht auf | - Netzstecker nicht eingesteckt.  | - Stecker in Steckdose stecken.<br>- Ausreichende Absicherung prüfen (siehe Kapitel Technische Daten).   |
| Druck zu niedrig   | - Hochdruckdüse verschlissen.<br>- Druckmengenregulierung bzw. VarioPress-Einrichtung <sup>1)</sup> auf zu niedrigen Druck eingestellt. | - Hochdruckdüse erneuern.<br>- Druckmengenregulierung am Regelsicherheitsblock in Richtung „+“ drehen bzw. VarioPress-Einrichtung) an der Pistole auf größere Wassermenge einstellen, (siehe Kapitel E10-11).  |
| Gerät läuft unruhig  | - Hochdruckpumpe saugt Luft aus leerem Reinigungsmittelbehälter.  | - Reinigungsmittel-Dosierventil schließen. Sprührohr von Spritzpistole abnehmen. Spritzpistole betätigen und Gerät laufen lassen, bis die Luft aus dem System entwichen ist und die Pumpe wieder ruhig läuft.. |
| Reinigungsmittel bleiben aus   | - Reinigungsmittelbehälter leer.<br>- Reinigungsmittelbehälter verschlammte.<br>- Filter im Reinigungsmittelbehälter verschmutzt.       | - Reinigungsmittelbehälter auffüllen.<br>- Reinigungsmittelbehälter reinigen.<br>- Filter ausbauen und reinigen.   |
| Brenner verrußt  | - Brennstoff verunreinigt.<br>- Brenner verschmutzt oder nicht korrekt eingestellt.   | -  Niifisk Service.  |

## B6: Einstellung des Entkalkers

| 1. Gehäuse (A) öffnen.<br>Die Wasserhärte messen oder beim Wasserversorger erfragen. |          |       |           |           |         |              | 2. Den Einstellschalter (B) entsprechend der Wasserhärte einstellen |             |             |             |
|--|----------|-------|-----------|-----------|---------|--------------|---|-------------|-------------|-------------|
| mg/l   | Grains   | °dH   | °e        | °f        | ppm Ca  | Beschreibung | 9-15 l/min  | 16-20 l/min | 21-26 l/min | 27-33 l/min |
| 0,0-17   | 0-1      | 0-7   | 0-8,8     | 0-12,5    | 0-50    | Weich        | 0   | 0           | 0           | 0           |
| 17-60  | 1,1-3,5  |       |           |           |         | Leicht hart  | 0,5   | 1           | 2           | 2           |
| 60-128   | 3,6-7,5  | 7-14  | 8,8-17,5  | 12,5-25,1 | 51-150  | Mittelhart   | 1   | 1,5         | 2,5         | 3           |
| 128-180  | 7,6-10,5 | 14-21 | 17,5-26,3 | 25,1-37,6 | 151-300 | Hart         | 1,5   | 2           | 3           | 3,5         |
| >180   | >10,5    | >21   | >26,3     | >37,6     | >300    | Sehr hart    | 2   | 3           | 3,5         | 4           |

## Wartungsplan

|   | Wöchentlich | Bei Bedarf | Nach den ersten 50 Betriebsstunden   | Wenn Serviceleuchte aufleuchtet.  |
|---|-------------|------------|--|---|
| Wasserfilter  |             | ●          |  |   |
| Einlassfilter des Brennstofftanks überprüfen und reinigen                       |             | ●          |  |   |
| Internen Brennstofffilter überprüfen und reinigen                               |             | ●          |  |   |
| Brennstofftank reinigen   |             | ●          |  |   |
| Die Nippel der Schnellkupplungen von Schlauch, Sprühpistole und Lanze schmieren | ●           |            |  |   |
| Qualität des Pumpenöls überprüfen   | ●           |            |  |   |
| Pumpenöl wechseln   |             |            |  Niifisk Service |  Niifisk Service |

### EU-Konformitätserklärung

Wir,  
Niifisk A/S, Kornmarksvej 1, DK-2605 Broendby, DÄNEMARK

Erklären hiermit, dass die  
Produkte: Hochdruckreiniger - Professionell – Mobil mit Warmwasserbetrieb

Beschreibung: 230V, 400-460V, 1~, 3~, 50 Hz, IPX5

Typ: MH 3M, MH 4M, MH 5M, MH 6P, MH 7P

den folgenden Normen entsprechen:

EN 60335-1:2012+A11:2014

EN 60335-2-79:2012

EN 55014-1:2006+A1:2009+A2:2011

EN 55014-2:2015

EN 61000-3-2:2014

EN 61000-3-11:2000

Entsprechend den Vorschriften von:

Maschinenrichtlinie 2006/42/EG

EMV-Richtlinie 2014/30/EG

Outdoorrichtlinie 2000/14/EG – Konformitätsbewertungsverfahren nach Anlage V.

- Gemessener Schallleistungspegel: 72-76 dB(A);

- Garantierter Schallleistungspegel: 88-92 dB(A)



















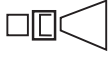
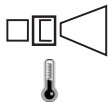

Hadsund, 28-09-2016























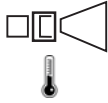

Anton Sørensen

Senior Vice President, Global R&D



















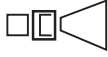
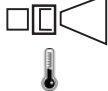

## Specifications

|    |   |                                      | MH 3M-140/580 PA     | MH 3M-100/600 PA     | MH 3M-160/770 PA     | MH 3M-160/770 PAX    | MH 4M-100/680 PA                    |  |
|----|---|--------------------------------------|----------------------|----------------------|----------------------|----------------------|-------------------------------------|--|
| 1  |    |                                      | EU                   | GB                   | EU                   | NO                   | GB                                  |  |
| 2  |    | V/ph/Hz                              | 230/1/50             | 230/1/50             | 400/3/50             | 230/400/3/50         | 230/1/50                            |  |
| 3  |    | A                                    | C 16                 | C 13                 | C 16                 | C 25/16              | C 13                                |  |
| 4  |    | kW<br>кВт                            | 3.6                  | 2.8                  | 4.7                  | 4.7                  | 2.9                                 |  |
| 5  |    | A                                    | 16                   | 12.5                 | 8                    | 14/8                 | 13                                  |  |
| 6  |    | bar<br>Бар<br>巴                      | 140                  | 100                  | 160                  | 160                  | 100                                 |  |
| 7  |    | l/min<br>л/мин<br>升/分钟               | 9.70                 | 10.00                | 11.70                | 11.70                | 10.50                               |  |
| 8  |    | bar<br>Бар<br>巴                      | 210                  | 150                  | 240                  | 240                  | 150                                 |  |
| 9  |    | l/min                                | 9.70                 | 10.00                | 12.80                | 12.80                | 11.30                               |  |
| 10 |   |                                      | NT 0370              | NT 0450              | NT 0400              | NT 0400              | NT 0475                             |  |
| 11 |  | °C                                   | 80/-                 | 80/-                 | 80/-                 | 80/-                 | 90/150                              |  |
| 12 |  | °C                                   | 40                   |                      |                      |                      |                                     |  |
| 13 |  | bar<br>Бар<br>巴                      | 10                   |                      |                      |                      |                                     |  |
| 14 |  | mm<br>毫米                             | 1010/700/1016        |                      |                      |                      |                                     |  |
| 15 |  | kg<br>кг                             | 114                  | 114                  | 133                  | 136                  | 138                                 |  |
| 16 |  | dB(A)<br>дБ(А)                       | 75.0                 | 75.0                 | 76.0                 | 76.0                 | 72.0                                |  |
| 17 |  | dB(A)<br>дБ(А)                       | 91.0                 | 91.0                 | 92.0                 | 92.0                 | 88.0                                |  |
| 18 |  | m/s <sup>2</sup><br>米/秒 <sup>2</sup> | 2.8 ±1               | 2.7 ±1               | 2.9 ±1               | 2.9 ±1               | 2.7 ±1                              |  |
| 19 |  | N                                    | 23.70                | 20.70                | 29.50                | 29.50                | 20.30                               |  |
| 20 |  | L<br>л<br>升                          | 0.39 / SAE<br>80W-90 | 0.39 / SAE<br>80W-90 | 0.39 / SAE<br>80W-90 | 0.39 / SAE<br>80W-90 | 0.75 / Castrol<br>Alphasyn<br>T 150 |  |
| 21 |  | kW<br>кВт                            | 42                   | 42                   | 55                   | 55                   | 70                                  |  |
| 22 |  | L/л/升                                | 15                   |                      |                      |                      |                                     |  |
| 23 |  | L/л/升                                | B: 10 L              | B: 10 L              | B: 10 L              | B: 10 L              | A: 10 L<br>B: +                     |  |





















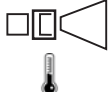

## Specifications

|    |   |                                      | MH 4M-<br>100/680 PAX               | MH 4M-<br>210/1000 PAX              | MH 4M-<br>130/720 FA                | MH 4M-<br>180/860 FAL               | MH 4M-<br>180/860 FA                |
|----|---|--------------------------------------|-------------------------------------|-------------------------------------|-------------------------------------|-------------------------------------|-------------------------------------|
| 1  |                                  |                                      | GB                                  | EU                                  | EU                                  | EU                                  | EU                                  |
| 2  |                                  | V/ph/Hz                              | 230/1/50                            | 400/3/50                            | 230/1/50                            | 400/3/50                            | 400/3/50                            |
| 3  |                                  | A                                    | C 13                                | C 16                                | C 16                                | C 16                                | C 16                                |
| 4  |                                  | kW<br>кВт                            | 2.9                                 | 8.0                                 | 3.6                                 | 5.9                                 | 5.9                                 |
| 5  |                                  | A                                    | 13                                  | 13.5                                | 16                                  | 10                                  | 10                                  |
| 6  |                                  | bar<br>Бар<br>巴                      | 100                                 | 210                                 | 130                                 | 180                                 | 180                                 |
| 7  |                                  | l/min<br>л/мин<br>升/分钟               | 10.50                               | 15.70                               | 11.00                               | 13.20                               | 13.20                               |
| 8  |                                  | bar<br>Бар<br>巴                      | 150                                 | 250                                 | 195                                 | 250                                 | 250                                 |
| 9  |                                  | l/min                                | 11.30                               | 16.70                               | 12.00                               | 14.30                               | 14.30                               |
| 10 |                                 |                                      | NT 0475                             | NT 0475                             | NT 0435                             | NT 0435                             | NT 0435                             |
| 11 |                                | °C                                   | 90/150                              | 90/150                              | 90/150                              | 90/150                              | 90/150                              |
| 12 |                                | °C                                   | 40                                  |                                     |                                     |                                     |                                     |
| 13 |                                | bar<br>Бар<br>巴                      | 10                                  |                                     |                                     |                                     |                                     |
| 14 |                                | mm<br>毫米                             | 1010/700/1016                       |                                     |                                     |                                     |                                     |
| 15 |                                | kg<br>кг                             | 141                                 | 149                                 | 141                                 | 133                                 | 133                                 |
| 16 | <br>K <sub>PA</sub> = 3 dB     | dB(A)<br>дБ(A)                       | 72.0                                | 76.0                                | 73.0                                | 75.0                                | 75.0                                |
| 17 | <br>K <sub>WA</sub> = 3 dB     | dB(A)<br>дБ(A)                       | 88.0                                | 92.0                                | 89.0                                | 91.0                                | 91.0                                |
| 18 | <br>(ISO 5349 a <sub>v</sub> ) | m/s <sup>2</sup><br>米/秒 <sup>2</sup> | 2.7 ±1                              | 3.3 ±1                              | 2.8 ±1                              | 3.1 ±1                              | 3.1 ±1                              |
| 19 |                                | N                                    | 20.50                               | 46.70                               | 25.40                               | 35.40                               | 35.40                               |
| 20 |                                | L<br>л<br>升                          | 0.75 / Castrol<br>Alphasyn<br>T 150 | 0.75 / Castrol<br>Alphasyn<br>T 150 | 0.75 / Castrol<br>Alphasyn<br>T 150 | 0.75 / Castrol<br>Alphasyn<br>T 150 | 0.75 / Castrol<br>Alphasyn<br>T 150 |
| 21 |                                | kW<br>кВт                            | 70                                  | 70                                  | 55                                  | 70                                  | 70                                  |
| 22 |                                | L/л/升                                | 15                                  |                                     |                                     |                                     |                                     |
| 23 |                                | L/л/升                                | A: 10 L<br>B: +                     | A: 10 L<br>B: +                     | A: 10 L<br>B: +                     | B: 10 L                             | A: 10 L<br>B: +                     |



















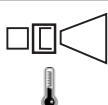

## Specifications

|    |   |                                      | MH 4M-180/890 FA                    | MH 4M-180/890 FA                    | MH 4M-200/960 FA                    | MH 4M-200/960 FA                    | MH 4M-200/960 FAX                   |
|----|---|--------------------------------------|-------------------------------------|-------------------------------------|-------------------------------------|-------------------------------------|-------------------------------------|
| 1  |                                  |                                      | JP                                  | JP                                  | EU                                  | NO                                  | EU                                  |
| 2  |                                  | V/ph/Hz                              | 200/3/50                            | 200/3/60                            | 400/3/50                            | 230/400/3/50                        | 400/3/50                            |
| 3  |                                  | A                                    | C 20                                | C 20                                | C 16                                | C 25/16                             | C 16                                |
| 4  |                                  | kW<br>кВт                            | 5.9                                 | 5.9                                 | 7.2                                 | 7.2                                 | 7.2                                 |
| 5  |                                  | A                                    | 20                                  | 20                                  | 12                                  | 21/12                               | 12                                  |
| 6  |                                  | bar<br>Бар<br>巴                      | 180                                 | 180                                 | 200                                 | 200                                 | 200                                 |
| 7  |                                  | l/min<br>л/мин<br>升/分钟               | 13.80                               | 13.80                               | 14.80                               | 14.80                               | 14.80                               |
| 8  |                                  | bar<br>Бар<br>巴                      | 250                                 | 250                                 | 250                                 | 250                                 | 250                                 |
| 9  |                                  | l/min                                | 14.80                               | 14.80                               | 16.00                               | 16.00                               | 16.00                               |
| 10 |                                 |                                      | NT 0475                             | NT 0475                             | NT 0475                             | NT 0475                             | NT 0475                             |
| 11 |                                | °C                                   | 90/150                              | 90/150                              | 90/150                              | 90/150                              | 90/150                              |
| 12 |                                | °C                                   | 40                                  |                                     |                                     |                                     |                                     |
| 13 |                                | bar<br>Бар<br>巴                      | 10                                  |                                     |                                     |                                     |                                     |
| 14 |                                | mm<br>毫米                             | 1010/700/1016                       |                                     |                                     |                                     |                                     |
| 15 |                                | kg<br>кг                             | 133                                 | 133                                 | 142                                 | 144                                 | 142                                 |
| 16 | <br>K <sub>PA</sub> = 3 dB     | dB(A)<br>дБ(A)                       | 75.0                                | 75.0                                | 76.0                                | 76.0                                | 76.0                                |
| 17 | <br>K <sub>WA</sub> = 3 dB     | dB(A)<br>дБ(A)                       | 91.0                                | 91.0                                | 92.0                                | 92.0                                | 92.0                                |
| 18 | <br>(ISO 5349 a <sub>h</sub> ) | m/s <sup>2</sup><br>米/秒 <sup>2</sup> | 3.1 ±1                              | 3.2 ±1                              | 3.2 ±1                              | 3.2 ±1                              | 3.2 ±1                              |
| 19 |                                | N                                    | 38.50                               | 40.30                               | 42.80                               | 42.80                               | 43.30                               |
| 20 |                                | L<br>л<br>升                          | 0.75 / Castrol<br>Alphasyn<br>T 150 | 0.75 / Castrol<br>Alphasyn<br>T 150 | 0.75 / Castrol<br>Alphasyn<br>T 150 | 0.75 / Castrol<br>Alphasyn<br>T 150 | 0.75 / Castrol<br>Alphasyn<br>T 150 |
| 21 |                                | kW<br>кВт                            | 70                                  | 70                                  | 70                                  | 70                                  | 70                                  |
| 22 |                                | L/л/升                                | 15                                  |                                     |                                     |                                     |                                     |
| 23 |                                | L/л/升                                | A: 10 L<br>B: +                     | A: 10 L<br>B: +                     | A: 10 L<br>B: +                     | A: 10 L<br>B: +                     | A: 10 L<br>B: +                     |

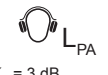
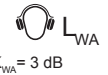

















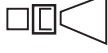
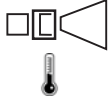

## Specifications

|    |   |                                      | MH 4M-<br>200/960 FAX               | MH 4M-<br>200/960 FA                | MH 4M-<br>220/1000 FA               | MH4M-<br>220/1000 FAXT              |
|----|---|--------------------------------------|-------------------------------------|-------------------------------------|-------------------------------------|-------------------------------------|
| 1  |                                  |                                      | NO                                  | EXP                                 | EU                                  | EU                                  |
| 2  |                                  | V/ph/Hz                              | 230/400/3/50                        | 220-230/440-<br>460/3/60            | 400/3/50                            | 400/3/50                            |
| 3  |                                  | A                                    | C 25/16                             | C 25/16                             | C 16                                | C 16                                |
| 4  |                                  | kW<br>кВт                            | 7.2                                 | 7.2                                 | 7.2                                 | 7.2                                 |
| 5  |                                  | A                                    | 21/12                               | 21/12                               | 14                                  | 14                                  |
| 6  |                                  | bar<br>Бар<br>巴                      | 200                                 | 200                                 | 220                                 | 220                                 |
| 7  |                                  | l/min<br>л/мин<br>升/分钟               | 14.80                               | 14.80                               | 15.70                               | 15.70                               |
| 8  |                                  | bar<br>Бар<br>巴                      | 250                                 | 250                                 | 250                                 | 250                                 |
| 9  |                                  | l/min                                | 16.00                               | 16.00                               | 16.70                               | 16.70                               |
| 10 |                                 |                                      | NT 0475                             | NT 0475                             | NT 0475                             | NT 0475                             |
| 11 |                                | °C                                   | 90/150                              | 90/150                              | 90/150                              | 90/150                              |
| 12 |                                | °C                                   | 40                                  |                                     |                                     |                                     |
| 13 |                                | bar<br>Бар<br>巴                      | 10                                  |                                     |                                     |                                     |
| 14 |                                | mm<br>毫米                             | 1010/700/1016                       |                                     |                                     |                                     |
| 15 |                                | kg<br>кг                             | 147                                 | 142                                 | 142                                 | 149                                 |
| 16 | <br>K <sub>PA</sub> = 3 dB     | dB(A)<br>дБ(A)                       | 76.0                                | 76.0                                | 76.0                                | 76.0                                |
| 17 | <br>K <sub>WA</sub> = 3 dB     | dB(A)<br>дБ(A)                       | 92.0                                | 92.0                                | 92.0                                | 92.0                                |
| 18 | <br>(ISO 5349 a <sub>v</sub> ) | m/s <sup>2</sup><br>米/秒 <sup>2</sup> | 3.2 ±1                              | 3.2 ±1                              | 3.4 ±1                              | 3.4 ±1                              |
| 19 |                                | N                                    | 43.30                               | 42.90                               | 47.20                               | 47.30                               |
| 20 |                                | L<br>л<br>升                          | 0.75 / Castrol<br>Alphasyn<br>T 150 | 0.75 / Castrol<br>Alphasyn<br>T 150 | 0.75 / Castrol<br>Alphasyn<br>T 150 | 0.75 / Castrol<br>Alphasyn<br>T 150 |
| 21 |                                | kW<br>кВт                            | 70                                  | 70                                  | 70                                  | 70                                  |
| 22 |                                | L/л/升                                | 15                                  |                                     |                                     |                                     |
| 23 |                                | L/л/升                                | A: 10 L<br>B: +                     | A: 10 L<br>B: +                     | A: 10 L<br>B: +                     | A: 10 L<br>B: +                     |

## Specifications

|    |   |                                      | MH 5M-100/760 PA UK                 | MH 5M-100/760 PAX UK                | MH 5M-200/960 FA                    | MH 5M-200/960 FAX                   | MH 5M-210/1100 FA                   |
|----|---|--------------------------------------|-------------------------------------|-------------------------------------|-------------------------------------|-------------------------------------|-------------------------------------|
| 1  |                                  |                                      | GB                                  | GB                                  | EU                                  | EU                                  | EU                                  |
| 2  |                                  | V/ph/Hz                              | 230/1/50                            | 230/1/50                            | 400/3/50                            | 400/3/50                            | 400/3/50                            |
| 3  |                                  | A                                    | C 13                                | C 13                                | C 16                                | C 16                                | C 16                                |
| 4  |                                  | kW<br>кВт                            | 2.9                                 | 2.9                                 | 7.2                                 | 7.2                                 | 7.9                                 |
| 5  |                                  | A                                    | 13                                  | 13                                  | 12                                  | 12                                  | 13.5                                |
| 6  |                                  | bar<br>Бар<br>巴                      | 100                                 | 100                                 | 200                                 | 200                                 | 210                                 |
| 7  |                                  | l/min<br>л/мин<br>升/分钟               | 11.30                               | 11.30                               | 14.80                               | 14.80                               | 17.50                               |
| 8  |                                  | bar<br>Бар<br>巴                      | 150                                 | 150                                 | 250                                 | 250                                 | 250                                 |
| 9  |                                 | l/min                                | 12.70                               | 12.70                               | 16.00                               | 16.00                               | 18.30                               |
| 10 |                                |                                      | NT 0500                             | NT 0500                             | NT 0475                             | NT 0475                             | NT 0550                             |
| 11 |                                | °C                                   | 90/150                              | 90/150                              | 90/150                              | 90/150                              | 90/150                              |
| 12 |                                | °C                                   | 40                                  |                                     |                                     |                                     |                                     |
| 13 |                                | bar<br>Бар<br>巴                      | 10                                  |                                     |                                     |                                     |                                     |
| 14 |                                | mm<br>毫米                             | 1188/ 700/ 1020                     |                                     |                                     |                                     |                                     |
| 15 |                                | kg<br>кг                             | 167                                 | 170                                 | 174                                 | 171                                 | 174                                 |
| 16 | <br>$K_{PA} = 3 \text{ dB}$    | dB(A)<br>дБ(A)                       | 73.3                                | 73.3                                | 75.3                                | 75.3                                | 76.9                                |
| 17 | <br>$K_{WA} = 3 \text{ dB}$    | dB(A)<br>дБ(A)                       | 88.4                                | 88.4                                | 90.4                                | 90.4                                | 92.0                                |
| 18 | <br>(ISO 5349 a <sub>v</sub> ) | m/s <sup>2</sup><br>米/秒 <sup>2</sup> | 2.0 ±1                              | 2.0 ±1                              | 2.0 ±1                              | 2.0 ±1                              | 2.0 ±1                              |
| 19 |                                | N                                    | 23.60                               | 23.80                               | 42.70                               | 43.20                               | 52.80                               |
| 20 |                                | L<br>л<br>升                          | 0.75 / Castrol<br>Alphasyn<br>T 150 | 0.75 / Castrol<br>Alphasyn<br>T 150 | 0.75 / Castrol<br>Alphasyn<br>T 150 | 0.75 / Castrol<br>Alphasyn<br>T 150 | 0.75 / Castrol<br>Alphasyn<br>T 150 |
| 21 |                                | kW<br>кВт                            | 70                                  | 70                                  | 80                                  | 80                                  | 90                                  |
| 22 |                                | L/л/升                                | 30                                  |                                     |                                     |                                     |                                     |
| 23 |                                | L/л/升                                | A: 10 L<br>B: 10 L                  | A: 10 L<br>B: 10 L                  | A: 10 L<br>B: 10 L                  | A: 10 L<br>B: 10 L                  | A: 10 L<br>B: 10 L                  |

## Specifications























|    |   |                                      | MH 5M-210/1100 FAX                  | MH 5M-210/1100 FA                   | MH 5M-210/1100 FAX                  | MH 5M-210/1100 PAX                  | MH 5M-210/1100 FA                   |
|----|---|--------------------------------------|-------------------------------------|-------------------------------------|-------------------------------------|-------------------------------------|-------------------------------------|
| 1  |                                  |                                      | EU                                  | NO                                  | NO                                  | EU                                  | EXP                                 |
| 2  |                                  | V/ph/Hz                              | 400/3/50                            | 230/400/3/50                        | 230/400/3/50                        | 400/3/50                            | 220-230/440-460/3/60                |
| 3  |                                  | A                                    | C 16                                | C 25/16                             | C 25/16                             | C 16                                | C 25/16                             |
| 4  |                                  | kW<br>кВт                            | 7.9                                 | 7.9                                 | 7.9                                 | 7.9                                 | 7.9                                 |
| 5  |                                  | A                                    | 13.5                                | 24/13.5                             | 24/13.5                             | 13.5                                | 24/13.5                             |
| 6  |                                  | bar<br>Бар<br>巴                      | 210                                 | 210                                 | 210                                 | 210                                 | 210                                 |
| 7  |                                  | l/min<br>л/мин<br>升/分钟               | 17.50                               | 17.50                               | 17.50                               | 17.50                               | 17.50                               |
| 8  |                                  | bar<br>Бар<br>巴                      | 250                                 | 250                                 | 250                                 | 250                                 | 250                                 |
| 9  |                                 | l/min                                | 18.30                               | 18.30                               | 18.30                               | 18.30                               | 18.30                               |
| 10 |                                |                                      | NT 0550                             | NT 0550                             | NT 0550                             | NT 0550                             | NT 0550                             |
| 11 |                                | °C                                   | 90/150                              | 90/150                              | 90/150                              | 90/150                              | 90/150                              |
| 12 |                                | °C                                   | 40                                  |                                     |                                     |                                     |                                     |
| 13 |                                | bar<br>Бар<br>巴                      | 10                                  |                                     |                                     |                                     |                                     |
| 14 |                                | mm<br>毫米                             | 1188/ 700/ 1020                     |                                     |                                     |                                     |                                     |
| 15 |                                | kg<br>кг                             | 179                                 | 174                                 | 180                                 | 179                                 | 180                                 |
| 16 | <br>$K_{PA} = 3 \text{ dB}$    | dB(A)<br>дБ(A)                       | 76.9                                | 76.9                                | 76.9                                | 76.9                                | 76.9                                |
| 17 | <br>$K_{WA} = 3 \text{ dB}$    | dB(A)<br>дБ(A)                       | 92.0                                | 92.0                                | 92.0                                | 92.0                                | 92.0                                |
| 18 | <br>(ISO 5349 a <sub>v</sub> ) | m/s <sup>2</sup><br>米/秒 <sup>2</sup> | 2.0 ±1                              | 2.0 ±1                              | 2.0 ±1                              | 2.0 ±1                              | 2.0 ±1                              |
| 19 |                                | N                                    | 53.60                               | 52.80                               | 53.60                               | 52.40                               | 52.80                               |
| 20 |                                | L<br>л<br>升                          | 0.75 / Castrol<br>Alphasyn<br>T 150 | 0.75 / Castrol<br>Alphasyn<br>T 150 | 0.75 / Castrol<br>Alphasyn<br>T 150 | 0.75 / Castrol<br>Alphasyn<br>T 150 | 0.75 / Castrol<br>Alphasyn<br>T 150 |
| 21 |                                | kW<br>кВт                            | 90                                  | 90                                  | 90                                  | 90                                  | 90                                  |
| 22 |                                | L/л/升                                | 30                                  |                                     |                                     |                                     |                                     |
| 23 |                                | L/л/升                                | A: 10 L<br>B: 10 L                  | A: 10 L<br>B: 10 L                  | A: 10 L<br>B: 10 L                  | A: 10 L<br>B: 10 L                  | A: 10 L<br>B: 10 L                  |

## Specifications



















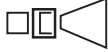
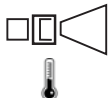

|    |                                |                                      | MH 6P-<br>210/1100 FA               | MH 6P-<br>210/1100 FA               | MH 6P-<br>175/1250 FA<br>EU         | MH 6P-<br>175/1250<br>FAX EU        | MH 6P-<br>200/1300 FA               |
|----|--------------------------------|--------------------------------------|-------------------------------------|-------------------------------------|-------------------------------------|-------------------------------------|-------------------------------------|
| 1  |                                |                                      | JP                                  | JP                                  | EU                                  | EU                                  | EU                                  |
| 2  |                                | V/ph/Hz                              | 200/3/50                            | 200/3/60                            | 400/3/50                            | 400/3/50                            | 400/3/50                            |
| 3  |                                | A                                    | C 30                                | C 30                                | C 16                                | C 16                                | C 16                                |
| 4  |                                | kW<br>кВт                            | 8.8                                 | 8.7                                 | 8.5                                 | 8.5                                 | 9.1                                 |
| 5  |                                | A                                    | 29                                  | 28                                  | 14.5                                | 14.5                                | 15.5                                |
| 6  |                                | bar<br>Бар<br>巴                      | 210                                 | 210                                 | 175                                 | 175                                 | 200                                 |
| 7  |                                | l/min<br>л/мин<br>升/分钟               | 17.50                               | 17.50                               | 19.20                               | 19.20                               | 20.00                               |
| 8  |                                | bar<br>Бар<br>巴                      | 250                                 | 250                                 | 250                                 | 250                                 | 250                                 |
| 9  |                                | l/min                                | 18.30                               | 18.30                               | 20.80                               | 20.80                               | 21.70                               |
| 10 |                                |                                      | NT 0550                             | NT 0550                             | NT 0750                             | NT 0750                             | NT 0680                             |
| 11 |                                | °C                                   | 90/150                              | 90/150                              | 90/150                              | 90/150                              | 90/150                              |
| 12 |                                | °C                                   | 40                                  |                                     |                                     |                                     |                                     |
| 13 |                                | bar<br>Бар<br>巴                      | 10                                  |                                     |                                     |                                     |                                     |
| 14 |                                | mm<br>毫米                             | 1188/ 700/<br>1020                  | 1188/ 700/<br>1020                  | 1188/ 700/<br>1020                  | 1188/ 700/<br>1020                  | 1188/ 700/<br>1045                  |
| 15 |                                | kg<br>кг                             | 179                                 | 179                                 | 180                                 | 188                                 | 198                                 |
| 16 | <br>K <sub>PA</sub> = 3 dB     | dB(A)<br>дБ(А)                       | 76.9                                | 76.9                                | 78.8                                | 78.8                                | 78.8                                |
| 17 | <br>K <sub>WA</sub> = 3 dB     | dB(A)<br>дБ(А)                       | 92.0                                | 92.0                                | 91.2                                | 91.2                                | 92.2                                |
| 18 | <br>(ISO 5349 a <sub>v</sub> ) | m/s <sup>2</sup><br>米/秒 <sup>2</sup> | 2.6 ±1                              | 2.6 ±1                              | 2.6 ±1                              | 2.6 ±1                              | 2.6 ±1                              |
| 19 |                                | N                                    | 52.80                               | 52.80                               | 55.40                               | 56.60                               | 59.50                               |
| 20 |                                | L<br>л<br>升                          | 0.95 / Castrol<br>Alphasyn<br>T 150 | 0.95 / Castrol<br>Alphasyn<br>T 150 | 0.95 / Castrol<br>Alphasyn<br>T 150 | 0.95 / Castrol<br>Alphasyn<br>T 150 | 0.95 / Castrol<br>Alphasyn<br>T 150 |
| 21 |                                | kW<br>кВт                            | 90                                  | 90                                  | 90                                  | 90                                  | 115                                 |
| 22 |                                | L/л/升                                | 30                                  |                                     |                                     |                                     |                                     |
| 23 |                                | L/л/升                                | A: 10 L<br>B: 10 L                  | A: 10 L<br>B: 10 L                  | A: 10 L<br>B: 10 L                  | A: 10 L<br>B: 10 L                  | A: 10 L<br>B: 10 L                  |



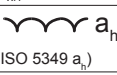





## Specifications





|    |   |                                      | MH 6P-<br>200/1300 FA               | MH 6P-<br>200/1300<br>FAX           | MH 6P-<br>195/1350 FA<br>EXPT       | MH 7P-<br>180/1260 FA               | MH 7P-<br>180/1260 FA               |
|----|---|--------------------------------------|-------------------------------------|-------------------------------------|-------------------------------------|-------------------------------------|-------------------------------------|
| 1  |                                  |                                      | NO                                  | EU                                  | EXP                                 | EU                                  | NO                                  |
| 2  |                                  | V/ph/Hz                              | 230/400/3/50                        | 400/3/50                            | 220-230/440-<br>460/400/<br>3/60    | 400/3/50                            | 230/400/3/60                        |
| 3  |                                  | A                                    | C 25/16                             | C 16                                | C 25/16                             | C 16                                | C 25/16                             |
| 4  |                                  | kW<br>кВт                            | 9.1                                 | 9.2                                 | 9.2                                 | 7.6                                 | 7.7                                 |
| 5  |                                  | A                                    | 25/14                               | 15.7                                | 25/13                               | 13.5                                | 24/14                               |
| 6  |                                  | bar<br>Бар<br>巴                      | 200                                 | 200                                 | 195                                 | 180                                 | 180                                 |
| 7  |                                  | l/min<br>л/мин<br>升/分钟               | 20.00                               | 20.00                               | 20. 80                              | 19.50                               | 19.50                               |
| 8  |                                  | bar<br>Бар<br>巴                      | 250                                 | 250                                 | 250                                 | 250                                 | 250                                 |
| 9  |                                 | l/min                                | 21.70                               | 21.70                               | 22.50                               | 21.00                               | 21.00                               |
| 10 |                                |                                      | NT 0680                             | NT 0680                             | NT 0700                             | NT 0680                             | NT 0680                             |
| 11 |                                | °C                                   | 90/150                              | 90/150                              | 90/150                              | 90/150                              | 90/150                              |
| 12 |                                | °C                                   | 40                                  |                                     |                                     |                                     |                                     |
| 13 |                                | bar<br>Бар<br>巴                      | 10                                  |                                     |                                     |                                     |                                     |
| 14 |                                | mm<br>毫米                             | 1188/ 700/<br>1045                  | 1188/ 700/<br>1045                  | 1188/ 700/<br>1045                  | 1188/ 700/<br>1045                  | 1188/ 700/<br>1045                  |
| 15 |                                | kg<br>кг                             | 207                                 | 207                                 | 216                                 | 195                                 | 199                                 |
| 16 | <br>K <sub>PA</sub> = 3 dB     | dB(A)<br>дБ(A)                       | 78.8                                | 78.8                                | 78.8                                | 76.5                                | 76.5                                |
| 17 | <br>K <sub>WA</sub> = 3 dB     | dB(A)<br>дБ(A)                       | 92.2                                | 92.2                                | 92.2                                | 91.6                                | 91.6                                |
| 18 | <br>(ISO 5349 a <sub>h</sub> ) | m/s <sup>2</sup><br>米/秒 <sup>2</sup> | 2.6 ±1                              | 2.6 ±1                              | 2.6 ±1                              | 3.4 ±1                              | 3.4 ±1                              |
| 19 |                                | N                                    | 59.70                               | 60.20                               | 61.20                               | 55.40                               | 55.40                               |
| 20 |                                | L<br>л<br>升                          | 0.95 / Castrol<br>Alphasyn<br>T 150 | 0.95 / Castrol<br>Alphasyn<br>T 150 | 0.95 / Castrol<br>Alphasyn<br>T 150 | 1.10 / Castrol<br>Alphasyn<br>T 150 | 1.10 / Castrol<br>Alphasyn<br>T 150 |
| 21 |                                | kW<br>кВт                            | 115                                 | 115                                 | 115                                 | 115                                 | 115                                 |
| 22 |                                | L/л/升                                | 30                                  |                                     |                                     |                                     |                                     |
| 23 |                                | L/л/升                                | A: 10 L<br>B: 10 L                  | A: 10 L<br>B: 10 L                  | A: 10 L<br>B: 10 L                  | A: 10 L<br>B: 10 L                  | A: 10 L<br>B: 10 L                  |



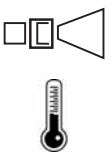



## Specifications



|    |   |                                      | MH 7P-180/1260 FAX                  | MH 7P-180/1260 FAX                  | MH 7P-180/1260 FA                   | MH 7P-180/1260 FA                   |
|----|---|--------------------------------------|-------------------------------------|-------------------------------------|-------------------------------------|-------------------------------------|
| 1  |                                  |                                      | EU                                  | NO                                  | JP                                  | JP                                  |
| 2  |                                  | V/ph/Hz                              | 400/3/50                            | 230/400/3/50                        | 200/3/50                            | 200/3/60                            |
| 3  |                                  | A                                    | C 16                                | C 25/16                             | C 20                                | C 20                                |
| 4  |                                  | kW<br>кВт                            | 7.6                                 | 7.7                                 | 7.7                                 | 7.3                                 |
| 5  |                                  | A                                    | 13.5                                | 25/14.5                             | 27.5                                | 27.5                                |
| 6  |                                  | bar<br>Бар<br>巴                      | 180                                 | 180                                 | 180                                 | 180                                 |
| 7  |                                  | l/min<br>л/мин<br>升/分钟               | 19.50                               | 19.50                               | 19.50                               | 19.50                               |
| 8  |                                  | bar<br>Бар<br>巴                      | 250                                 | 250                                 | 250                                 | 250                                 |
| 9  |                                 | l/min                                | 21.00                               | 21.00                               | 21.00                               | 21.00                               |
| 10 |                                |                                      | NT 0680                             | NT 0680                             | NT 0680                             | NT 0680                             |
| 11 |                                | °C                                   | 90/150                              | 90/150                              | 90/150                              | 90/150                              |
| 12 |                                | °C                                   | 40                                  |                                     |                                     |                                     |
| 13 |                                | bar<br>Бар<br>巴                      | 10                                  |                                     |                                     |                                     |
| 14 |                                | mm<br>毫米                             | 1188/ 700/<br>1045                  | 1188/ 700/<br>1045                  | 1188/ 700/<br>1045                  | 1188/ 700/<br>1045                  |
| 15 |                                | kg<br>кг                             | 204                                 | 208                                 | 195                                 | 195                                 |
| 16 | <br>$K_{PA} = 3 \text{ dB}$    | dB(A)<br>дБ(A)                       | 76.5                                | 76.5                                | 76.5                                | 76.5                                |
| 17 | <br>$K_{WA} = 3 \text{ dB}$    | dB(A)<br>дБ(A)                       | 91.6                                | 91.6                                | 91.6                                | 91.6                                |
| 18 | <br>(ISO 5349 a <sub>v</sub> ) | m/s <sup>2</sup><br>米/秒 <sup>2</sup> | 3.4 ±1                              | 3.4 ±1                              | 3.4 ±1                              | 3.4 ±1                              |
| 19 |                                | N                                    | 56.00                               | 56.00                               | 55.80                               | 55.20                               |
| 20 |                                | L<br>л<br>升                          | 1.10 / Castrol<br>Alphasyn<br>T 150 | 1.10 / Castrol<br>Alphasyn<br>T 150 | 1.10 / Castrol<br>Alphasyn<br>T 150 | 1.10 / Castrol<br>Alphasyn<br>T 150 |
| 21 |                                | kW<br>кВт                            | 115                                 | 115                                 | 115                                 | 115                                 |
| 22 |                                | L/л/升                                | 30                                  |                                     |                                     |                                     |
| 23 |                                | L/л/升                                | A: 10 L<br>B: 10 L                  | A: 10 L<br>B: 10 L                  | A: 10 L<br>B: 10 L                  | A: 10 L<br>B: 10 L                  |

|   |   |                 |  |
|---|---|-----------------|--|
| 1 |    |                 | <b>EN:</b> Country variant. <b>DE:</b> Ländervarianten. <b>FR:</b> Selon le pays. <b>NL:</b> Nationale variant. <b>IT:</b> Variante per il Paese. <b>NO:</b> Variant i ulike land. <b>SV:</b> Landsvariant. <b>DA:</b> Landespecifik variant. <b>FI:</b> Maakohtainen vaihtelu. <b>ES:</b> Dependé del país. <b>PT:</b> Variante do país. <b>EL:</b> Έκδοση χώρας. <b>TR:</b> Ülkedeki model. <b>SL:</b> Jezikovna različica. <b>HR:</b> Ovisno o zemlji. <b>SK:</b> Vrsta ulja. <b>CS:</b> Varianta země. <b>PL:</b> Wersja dla kraju. <b>HU:</b> Országfüggő modellváltozatok. <b>RO:</b> Varianta țării. <b>BG:</b> Вариант за страната. <b>RU:</b> Региональное исполнение. <b>ET:</b> Riigi variant. <b>LV:</b> Valsts versija. <b>LT:</b> Šaliai skirtas variantas. <b>JA:</b> 国による相違。 <b>ZH:</b> 不同国家 <b>KO:</b> 국가별 모델. <b>TH:</b> แดกต่างกันไปตามประเทศ <b>MS:</b> Variasi negara.  |
| 2 |    | V/<br>ph/<br>Hz | <b>EN:</b> Possible voltage. <b>DE:</b> Mögliche Spannung. <b>FR:</b> Tension autorisée. <b>NL:</b> Mogelijke spanning. <b>IT:</b> Possibile voltaggio. <b>NO:</b> Mulig spenning. <b>SV:</b> Möjlig spänning. <b>DA:</b> Spænding. <b>FI:</b> Mahdollinen jännite, V/vaiheluku/taajuus. <b>ES:</b> Tensión admitida. <b>PT:</b> Tensão possível. <b>EL:</b> Πιθανή τάση, V/ph/Frez. <b>TR:</b> Olası voltaj, V/Faz/Frekans. <b>SL:</b> Morebitna napetost. <b>HR:</b> Mogući napon. <b>SK:</b> Možné napätie. <b>CS:</b> Možné napětí. <b>PL:</b> Dopuszczalne napięcie, V/fazy/częst. <b>HU:</b> Tápészültség, V/fázis/frekv. <b>RO:</b> Tensiune posibilă, V/fază/Frecv. <b>BG:</b> Възможно напрежение. <b>RU:</b> Напряжение, В/ф./част. В/ф./Гц. <b>ET:</b> Võimalik pinge, V/faas/sagedus. <b>LV:</b> Iespējamais spriegums. <b>LT:</b> Galima įtampa V / F / Frez. <b>JA:</b> 電圧。 <b>ZH:</b> 可能电压 ( V/ph/Frez ) <b>KO:</b> 허용 전압, 볼트/상/헤르츠. <b>TH:</b> แรงดันไฟฟ้าที่สามารถใช้ได้ <b>MS:</b> Kemungkinan voltan. |
| 3 |    | A               | <b>EN:</b> Fuse. <b>DE:</b> Sicherung. <b>FR:</b> Fusible. <b>NL:</b> Zekering. <b>IT:</b> Fusibile. <b>NO:</b> Sikring. <b>SV:</b> Säkring. <b>DA:</b> Sikring. <b>FI:</b> Sulake. <b>ES:</b> Fusible. <b>PT:</b> Fusível. <b>EL:</b> Ασφάλεια. <b>TR:</b> Sigorta. <b>SL:</b> Varovalka <b>HR:</b> Osigurač <b>SK:</b> Poistka <b>CS:</b> Pojistka. <b>PL:</b> Bezpiecznik. <b>HU:</b> Biztosíték. <b>RO:</b> Siguranță. <b>BG:</b> Предпазител <b>RU:</b> Предохранитель. <b>ET:</b> Kaitse. <b>LV:</b> Drošinātājs. <b>LT:</b> Saugiklis. <b>JA:</b> ヒューズ <b>ZH:</b> 保险丝 <b>KO:</b> 퓨즈. <b>TH:</b> ฟิวส์ <b>MS:</b> Fius   |
| 4 |  | kW<br>kBT       | <b>EN:</b> Power rating. <b>DE:</b> Nennleistung. <b>FR:</b> Puissance nominale. <b>NL:</b> Nominiaal vermogen. <b>IT:</b> Corrente nominale. <b>NO:</b> Nominell effekt. <b>SV:</b> Märkeffekt. <b>DA:</b> Nominel effekt. <b>FI:</b> Tehontarve. <b>ES:</b> Potencia nominal. <b>PT:</b> Classificação de potência. <b>EL:</b> Ονομαστική ισχύς. <b>TR:</b> Elektrik değerleri. <b>SL:</b> Moč. <b>HR:</b> Oznaka napona. <b>SK:</b> Stanovenie výkonu. <b>CS:</b> Jmenovitý výkon. <b>PL:</b> Moc znamionowa. <b>HU:</b> Névleges teljesítmény. <b>RO:</b> Putere nominală. <b>BG:</b> Мощност. <b>RU:</b> Номинальная мощность кВт. <b>ET:</b> Vooluühik. <b>LV:</b> Nominālā jauda. <b>LT:</b> Galia. <b>JA:</b> 定格電力。 <b>ZH:</b> 额定功率 <b>KO:</b> 전원 등급. <b>TH:</b> อัตรากำลังไฟ <b>MS:</b> Penarafan kuasa.  |
| 5 |  | A               | <b>EN:</b> Current consumption. <b>DE:</b> Aktueller Verbrauch. <b>FR:</b> Consommation de courant. <b>NL:</b> Huidig verbruik. <b>IT:</b> Consumo di corrente. <b>NO:</b> Strømforbruk. <b>SV:</b> Strömförbrukning. <b>DA:</b> Strømforbrug. <b>FI:</b> Nykyinen kulutus. <b>ES:</b> Consumo actual. <b>PT:</b> Consumo de corrente. <b>EL:</b> Κατανάλωση ρεύματος. <b>TR:</b> Geçerli tüketim. <b>SL:</b> Poraba električne energije. <b>HR:</b> Potrošnja struje. <b>SK:</b> Aktuálna spotreba. <b>CS:</b> Odběr proudu. <b>PL:</b> Pobór prądu. <b>HU:</b> Áramfelvétel. <b>RO:</b> Consum de curent. <b>BG:</b> Консумация на електроенергия. <b>RU:</b> Текущий расход. <b>ET:</b> Praegune tarbimine. <b>LV:</b> Strāvas patēriņš. <b>LT:</b> Esamas suvartojimas. <b>JA:</b> 消費電流。 <b>ZH:</b> 电流消耗。 <b>KO:</b> 소비 전류. <b>TH:</b> กำลังไฟฟ้า <b>MS:</b> Penggunaan semasa.  |
| 6 |  | bar<br>Бар<br>巴 | <b>EN:</b> Working pressure. <b>DE:</b> Arbeitsdruck. <b>FR:</b> Pression de service. <b>NL:</b> Werkdruk. <b>IT:</b> Pressione di esercizio. <b>NO:</b> Arbeidstrykk. <b>SV:</b> Arbetstryck. <b>DA:</b> Arbejdstryk. <b>FI:</b> Työpaine. <b>ES:</b> Presión de trabajo. <b>PT:</b> Pressão de trabalho. <b>EL:</b> Πίεση λειτουργίας. <b>TR:</b> Çalışma basıncı. <b>SL:</b> Delovni tlak. <b>HR:</b> Radni tlak. <b>SK:</b> Pracovní tlak. <b>CS:</b> Provozní tlak. <b>PL:</b> Ciśnienie robocze. <b>HU:</b> Üzemnyomás. <b>RO:</b> Presiune de lucru. <b>BG:</b> Работно налягане. <b>RU:</b> Рабочее давление. <b>ET:</b> Töösurve. <b>LV:</b> Darba spiediens. <b>LT:</b> Darbinis slėgis. <b>JA:</b> 動作圧力。 <b>ZH:</b> 工作压力 <b>KO:</b> 작업 압력. <b>TH:</b> แรงดันขณะใช้งาน <b>MS:</b> Tekanan kerja  |

|    |   |                        |  |
|----|---|------------------------|--|
| 7  |    | l/min<br>л/МИН<br>升/分钟 | <b>EN:</b> Water flow. <b>DE:</b> Wasserdurchsatz. <b>FR:</b> Débit d'eau. <b>NL:</b> Waterdoorstroming. <b>IT:</b> Flusso dell'acqua. <b>NO:</b> Vanntilførsel. <b>SV:</b> Vattenflöde. <b>DA:</b> Vandmængde. <b>FI:</b> Vedenvirtaus. <b>ES:</b> Flujo de agua. <b>PT:</b> Fluxo de água. <b>EL:</b> Ποή νερού. <b>TR:</b> Su akışı. <b>SL:</b> Pretok vode. <b>HR:</b> Regulacija protoka vode. <b>SK:</b> Prietok vody. <b>CS:</b> Průtok vody. <b>PL:</b> Przepływ wody. <b>HU:</b> Vízátfolyás. <b>RO:</b> Debit apă. <b>BG:</b> Воден поток. <b>RU:</b> Расход воды. <b>ET:</b> Veevool. <b>LV:</b> Ūdens plūsma. <b>LT:</b> Vandens srautas. <b>JA:</b> 流水 <b>ZH:</b> 水流量 <b>KO:</b> 급수량 <b>TH:</b> การไหลของน้ำ <b>MS:</b> Aliran air.   |
| 8  |    | bar<br>Бар<br>巴        | <b>EN:</b> Max. water pressure. <b>DE:</b> Max Wasserdruck. <b>FR:</b> Pression d'eau maximale. <b>NL:</b> Max. waterdruk. <b>IT:</b> Max. pressione dell'acqua. <b>NO:</b> Maks. vanntrykk. <b>SV:</b> Max vattentryck. <b>DA:</b> Max. vandtryk. <b>FI:</b> Suurin vedenpaine. <b>ES:</b> Presión máxima de entrada del agua. <b>PT:</b> Pressão máxima de água. <b>EL:</b> Μέγ. πίεση νερού. <b>TR:</b> Maks. su basıncı. <b>SL:</b> Najv. vodni tlak. <b>HR:</b> Maksimalni tlak vode. <b>SK:</b> Maximálny tlak vody. <b>CS:</b> Max. tlak vody. <b>PL:</b> Maks. ciśnienie wody. <b>HU:</b> Max. víznyomás. <b>RO:</b> Presiune max. apă. <b>BG:</b> Макс. налягане на водата. <b>RU:</b> Макс. давление воды. <b>ET:</b> Max veesurve. <b>LV:</b> Maks. ūdens spiediens. <b>LT:</b> Maks. vandens slėgis. <b>JA:</b> 最高水圧 <b>ZH:</b> 最大水压. <b>KO:</b> 최대 수압. <b>TH:</b> ความดันน้ำสูงสุด <b>MS:</b> Tekanan air maksimum.                                       |
| 9  |    | l/min<br>л/МИН<br>升/分钟 | <b>EN:</b> Water flow <b>DE:</b> Wasserdurchsatz. <b>FR:</b> Débit d'eau. <b>NL:</b> Waterdoorstroming. <b>IT:</b> Flusso dell'acqua. <b>NO:</b> Vanntilførsel. <b>SV:</b> Vattenflöde. <b>DA:</b> Vandmængde. <b>FI:</b> Vedenvirtaus. <b>ES:</b> Flujo de agua. <b>PT:</b> Fluxo de água. <b>EL:</b> Ποή νερού. <b>TR:</b> Su akışı. <b>SL:</b> Pretok vode. <b>HR:</b> Protok vode. <b>SK:</b> Prietok vody. <b>CS:</b> Průtok vody. <b>PL:</b> Przepływ wody. <b>HU:</b> Vízátfolyás. <b>RO:</b> Debit apă. <b>BG:</b> Воден поток. <b>RU:</b> Расход воды. <b>ET:</b> Veevool. <b>LV:</b> Ūdens plūsma. <b>LT:</b> Vandens srautas. <b>JA:</b> 流水. <b>ZH:</b> 水流量 <b>KO:</b> 급수량 <b>TH:</b> การไหลของน้ำ <b>MS:</b> Aliran air.   |
| 10 |  |                        | <b>EN:</b> High pressure nozzle <b>DE:</b> Hochdruckdüse. <b>FR:</b> Buse haute pression. <b>NL:</b> Hogedruksproeier. <b>IT:</b> Ugello alta pressione. <b>NO:</b> Høytrykksmunnstykke. <b>SV:</b> Högtrycksmunstycke. <b>DA:</b> Højtryksdyse. <b>FI:</b> Korkeapainesuutin. <b>ES:</b> Boquilla de alta presión. <b>PT:</b> Bocal de alta pressão. <b>EL:</b> Ακροφύσιο υψηλής πίεσης. <b>TR:</b> Yüksek basınçlı ağız. <b>SL:</b> Šoba za visoki pritisk. <b>HR:</b> Visokotlačna mlaznica. <b>SK:</b> Vysokotlaková hubica. <b>CS:</b> Vysokotlaková tryska. <b>PL:</b> Dysza wysokociśnieniowa. <b>HU:</b> Nagynyomású fúvóka. <b>RO:</b> Duză de înaltă presiune. <b>BG:</b> Дюза за високо налягане. <b>RU:</b> Сопло высокого давления. <b>ET:</b> Kõrgsurve otsak. <b>LV:</b> Augstspiediena sprausla. <b>LT:</b> Aukšto slėgio purkštukas. <b>JA:</b> 高压カノズル. <b>ZH:</b> 高压喷嘴. <b>KO:</b> 고압 노즐 <b>TH:</b> หัวฉีดแรงดันสูง <b>MS:</b> Nozel tekanan tinggi. |
| 11 |  | °C                     | <b>EN:</b> Water Temperature. <b>DE:</b> Wasser temperatur. <b>FR:</b> d'eau température. <b>NL:</b> Water temperatuur. <b>IT:</b> dell'acqua temperatura. <b>NO:</b> Vann temperatur. <b>SV:</b> Vatten temperatur. <b>DA:</b> Vandtemperatur. <b>FI:</b> Veden lämpötila. <b>ES:</b> agua temperatura. <b>PT:</b> água temperatura. <b>EL:</b> νερού θερμοκρασία. <b>TR:</b> Su sıcaklık. <b>SL:</b> vode temperatura. <b>HR:</b> vode temperatura. <b>SK:</b> vody teplota. <b>CS:</b> vody teplota. <b>PL:</b> wody temperatura. <b>HU:</b> Viz hőmérséklet. <b>RO:</b> apă temperatură. <b>BG:</b> Воден температура. <b>RU:</b> воды температура. <b>ET:</b> Vee temperatuur. <b>LV:</b> Ūdens temperatūra. <b>LT:</b> Vandens temperatūra. <b>JA:</b> 水温度. <b>ZH:</b> 水温度. <b>KO:</b> 물 온도. <b>TH:</b> น้ำอุณหภูมิที่ไซ <b>MS:</b> Air Suhu yang.   |

|    |   |                 |   |
|----|---|-----------------|---|
| 12 |    | °C              | <p><b>EN:</b> Max water inlet temperature, Intake-Pressure operation. <b>DE:</b> Max Wassereinlassstemperatur - Druckbetrieb. <b>FR:</b> Température max. de l'entrée d'eau en mode admission/pression. <b>NL:</b> Max. Waterinlaattemperatuur Inlaat-Tijdens. Bedrijf. <b>IT:</b> Temperatura max. alimentazione acqua Funzionamento a ingressopressione. <b>NO:</b> Maks. temperatur vanninntak, Inntakstrykk drift. <b>SV:</b> Max ingående vattentemperatur inlopps-tryckdrift. <b>DA:</b> Maks. vandtilgangstemperatur, tilgangstrykdrift. <b>FI:</b> Tuloveden suurin lämpötila, käytettäessä painepesurina. <b>ES:</b> Temperatura y presión máxima de entrada del agua. <b>PT:</b> Temperatura máxima de entrada de água, Funcionamento da pressão de entrada. <b>EL:</b> Μεγ. θερμοκρασία εισόδου νερού-λειτουργίας πίεσης. <b>TR:</b> Maks. su girişi sıcaklığı Emme-Basınçlı çalışma. <b>SL:</b> Najv. vstopna temperatura vode, vstopni tlak pri delovanju. <b>HR:</b> Maks. temperatura ulazne vode, tlak pri usisavanju. <b>SK:</b> Max. vstupná teplota vody, Prevádzka v nasávacom režime pod tlakom. <b>CS:</b> Max. teplota vody na vstupu, provozní sací tlak. <b>PL:</b> Maks. temperatura na dopływie wody z instalacji wodociągowej. <b>HU:</b> Max. bemenő vízhőmérséklet Szívónyomásos üzem. <b>RO:</b> Temperatura max. de admisie apă în cazul alimentării de la robinet. <b>BG:</b> Макс. температура на входящата вода – работа в режим на засмукване. <b>RU:</b> Макс. температура воды на входе (всасывание/подача под давлением). <b>ET:</b> Max vee sisselasketemperatuur Sissevõturiõhk töö ajal. <b>LV:</b> Maks. ūdens ieplūdes temperatūra ieplūdes-spiediena darbībā. <b>LT:</b> Didžiausia vandens paėmimo temperatūra, veikimas esant jėjimo slėgiui. <b>JA:</b> 最高流入水温度、吸気圧力動作。 <b>ZH:</b> 进水压力操作时的最高进水水温 <b>KO:</b> 최대 급수 온도 주입/압력 작동. <b>TH:</b> อุณหภูมิน้ำเข้าสูงสุด ความดันในการใช้งานบริเวณทางเข้า <b>MS:</b> Suhu maksimum air masuk, Kemasukan-Operasi tekanan.</p> |
| 13 |  | bar<br>Бар<br>巴 | <p><b>EN:</b> Max. water inlet pressure. <b>DE:</b> Max. Wassereinlassdruck. <b>FR:</b> d'eau en mode admission/pression. <b>NL:</b> Max. waterinlaatdruk. <b>IT:</b> Pressione max. alimentazione acqua. <b>NO:</b> Maks. trykk vanninntak. <b>SV:</b> Max tryck för vatteninlopp. <b>DA:</b> Maks. Vandtilgangstryk. <b>FI:</b> Tuloveden suurin paine. <b>ES:</b> Presión máxima de entrada del agua. <b>PT:</b> Pressão máxima de entrada de água. <b>EL:</b> Μεγ. πίεση εισόδου νερού. <b>TR:</b> Maks. su girişi basıncı. <b>SL:</b> Najv. tlak dovoda vode. <b>HR:</b> Maks. tlak ulazne vode. <b>SK:</b> Max. vstupný tlak vody. <b>CS:</b> Max. tlak vody na vstupu. <b>PL:</b> Maks. ciśnienie na dopływie wody. <b>HU:</b> Max. bemenő nyomás. <b>RO:</b> Presiunea max. de alimentare cu apă. <b>BG:</b> Макс. налягане на входяща вода. <b>RU:</b> Макс. давление воды на входе. <b>ET:</b> Maks vee sissevoolusurve. <b>LV:</b> Maks. ūdens spiediens. <b>LT:</b> Didžiausias vandens paėmimo slėgis. <b>JA:</b> 最高流入水圧。 <b>ZH:</b> 最大进水压力 <b>KO:</b> 최고 급수 압력. <b>TH:</b> ความดันน้ำเข้าสูงสุด <b>MS:</b> Tekanan maksimum air masuk.</p>  |
| 14 |  | mm<br>毫米        | <p><b>EN:</b> Dimensions LxWxH. <b>DE:</b> Masse LxBxH. <b>FR:</b> Dimensions l x p x h. <b>NL:</b> Afmetingen LxBxH. <b>IT:</b> Dimensioni, lun. x larg. x alt. <b>NO:</b> Mål LxBxH. <b>SV:</b> Dimensioner LxBxH. <b>DA:</b> Mål LxBxH. <b>FI:</b> Mitat, PxLxK. <b>ES:</b> Dimensiones l x a x al. <b>PT:</b> Dimensões, C x L x A. <b>EL:</b> Διαστάσεις, Μ x Π x Υ. <b>TR:</b> Boyutlar, u x g x y. <b>SL:</b> Mere D x Š x V. <b>HR:</b> Dimenzije DxŠxV. <b>SK:</b> Rozmery D x Š x V. <b>CS:</b> Rozměry d x š x v. <b>PL:</b> Wymiary długo. x szer. x wys. <b>HU:</b> Méretek H x Sz x M. <b>RO:</b> Dimensiuni. L x l x î. <b>BG:</b> Размери Д x Ш x В. <b>RU:</b> Размеры, Дл. x Шир. x Выс. <b>ET:</b> Mõõtmed p x l x k. <b>LV:</b> Izmēri G x P x A. <b>LT:</b> Matmenys (l x p x a). <b>JA:</b> 外形寸法長さx幅x高さ。 <b>ZH:</b> 尺寸 (长 x 宽 x 高) 毫米 <b>KO:</b> 크기 (l x w x h). <b>TH:</b> ขนาด ยาว x กว้าง x สูง <b>MS:</b> Dimensi LxWxH.</p>  |
| 15 |  | kg<br>кг        | <p><b>EN:</b> Weight. <b>DE:</b> Gewicht. <b>FR:</b> Poids du nettoyeur. <b>NL:</b> Gewicht van de hogedrukreiniger. <b>IT:</b> Peso dell'idropulitrice. <b>NO:</b> Vekt høytrykksvasker. <b>SV:</b> Maskinens vikt. <b>DA:</b> Vægt. <b>FI:</b> Pelkän painepesurin paino. <b>ES:</b> Peso del limpiador. <b>PT:</b> Peso da máquina de limpeza. <b>EL:</b> Βάρος μηχανήματος καθαρισμού. <b>TR:</b> Temizlik makinesinin yüksekliği. <b>SL:</b> Masa. <b>HR:</b> Težina. <b>SK:</b> Hmotnosť. <b>CS:</b> Hmotnost čisticího stroje. <b>PL:</b> Ciężar myjki. <b>HU:</b> Tisztítógép tömege. <b>RO:</b> Greutatea aparatului. <b>BG:</b> Тегло. <b>RU:</b> Вес моечной машины. <b>ET:</b> Pesuri kaal. <b>LV:</b> Tīrītāja svars. <b>LT:</b> Valymo įrenginio svoris. <b>JA:</b> 重量。 <b>ZH:</b> 清洗机重量 <b>KO:</b> 세척기 무게. <b>TH:</b> น้ำหนัก <b>MS:</b> Berat.</p>  |

|    |   |  |   |
|----|---|--|---|
| 16 | <br>(IEC 60335-2-79)           | <b>dB(A)</b><br><b>дБ(А)</b>                     | <b>EN:</b> Sound pressure level $L_{PA}$ <b>DE:</b> Schalldruckpegel <b>FR:</b> Niveau de pression acoustique <b>NL:</b> Geluidsdrukniveau <b>IT:</b> Livello pressione sonora <b>NO:</b> Lydtrykknivå <b>SV:</b> Ljudtrycksnivå <b>DA:</b> Lydtryksniveau <b>FI:</b> Äänenpainetaso <b>ES:</b> Nivel de presión sonora <b>PT:</b> Nível de pressão acústica <b>EL:</b> Επίπεδο πίεσης ήχου <b>TR:</b> Göre ses basıncı seviyesi <b>SL:</b> Raven zvočnega tlaka. <b>HR:</b> Razina zvučnog tlaka. <b>SK:</b> Hladina zvukového. <b>CS:</b> Hladina akustického tlaku <b>PL:</b> Poziom ciśnienia akustycznego <b>HU:</b> Hangnyomásszint <b>RO:</b> Nivel de presiune acustică <b>BG:</b> Ниво на звуково налягане <b>RU:</b> Уровень шума <b>ET:</b> Helisurve tase <b>LV:</b> Akustiskā spiediena līmenis <b>LT:</b> Garso slėgio lygis <b>JA:</b> 音圧レベル <b>ZH:</b> 声压级 <b>KO:</b> 음압 레벨 <b>TH:</b> ระดับความดันเสียง <b>MS:</b> Tahap tekanan bunyi   |
| 17 | <br>(IEC 60335-2-79)           | <b>dB(A)</b><br><b>дБ(А)</b>                     | <b>EN:</b> Sound power level $L_{WA}$ <b>DE:</b> Schallleistungspegel <b>FR:</b> Niveau de puissance acoustique <b>NL:</b> Geluidsvermogeniveau <b>IT:</b> Livello potenza sonora <b>NO:</b> Lydeffektnivå <b>SV:</b> Ljudeffektnivå <b>DA:</b> Lydeffektniveau <b>FI:</b> Äänen tehotaaso <b>ES:</b> Potencia acústica <b>PT:</b> Nível de potência acústica <b>EL:</b> Επίπεδο ισχύος ήχου <b>TR:</b> Göre ses basıncı seviyesi <b>SL:</b> Raven moči zvoka. <b>HR:</b> Razina jakosti. <b>SK:</b> Hladina zvukového výkonu. <b>CS:</b> Hladina akustického výkonu <b>PL:</b> Poziom mocy akustycznej <b>HU:</b> Hangteljesítmény szint <b>RO:</b> Nivelul de putere acustică <b>BG:</b> Ниво на звукова мощност <b>RU:</b> Уровень звуковой мощности <b>ET:</b> Helivõimsuse tase <b>LV:</b> Akustiskās jaudas līmenis <b>LT:</b> Garso galios lygis <b>JA:</b> 音響パワーレベル <b>ZH:</b> 声功率级 <b>KO:</b> 소음 레벨 <b>TH:</b> ระดับกำลังเสียง <b>MS:</b> Tahap kuasa bunyi  |
| 18 | <br>(ISO 5349 a <sub>n</sub> ) | <b>m/s<sup>2</sup></b><br><b>米/秒<sup>2</sup></b> | <b>EN:</b> Vibration. <b>DE:</b> Vibrationen <b>FR:</b> Vibration <b>NL:</b> Vibratie <b>IT:</b> Vibrazioni <b>NO:</b> Vibrasjoner <b>SV:</b> Vibration <b>DA:</b> Vibration <b>FI:</b> Tärinäarvot <b>ES:</b> Vibración <b>PT:</b> Vibração <b>EL:</b> Δόνηση <b>TR:</b> Titreşimi <b>SL:</b> Vibracije. <b>HR:</b> Vibracije. <b>SK:</b> Vibrácie. <b>CS:</b> Vibrace <b>PL:</b> Drgania <b>HU:</b> Vibráció <b>RO:</b> Vibrații <b>BG:</b> Вибрации. <b>RU:</b> Вибрация <b>ET:</b> vibratsioon <b>LV:</b> vibrācija <b>LT:</b> Vibracijos <b>JA:</b> 振動. <b>ZH:</b> 振动 <b>KO:</b> 진동 <b>TH:</b> แรงสั่นสะเทือน <b>MS:</b> Getaran.  |
| 19 |                              | <b>N</b>   | <b>EN:</b> Recoil forces, lance. <b>DE:</b> Rückstoßkraft, Sprühhrohr <b>FR:</b> Forces de recul, lance <b>NL:</b> Terugslagkracht, lans <b>IT:</b> Forze di rinculo, lancia <b>NO:</b> Rekylkraft, lanse <b>SV:</b> Rekylkraft, spolrör <b>DA:</b> Rekylkraft, dyserør <b>FI:</b> Rekyylivoimat, suutin <b>ES:</b> Fuerzas de retroceso, lanza <b>PT:</b> Forças de retrocesso, lança <b>EL:</b> Δυνάμεις οπισθοδρόμησης, διάταξη ψεκασμού χη. <b>TR:</b> Sarmal kuvvetler, boru <b>SL:</b> Povratne sile, šoba. <b>HR:</b> Trzajne sile, mlaznica. <b>SK:</b> Spätňý odraz, štandardná striekacia rúra. <b>CS:</b> Síly zpětného rázu, násadec <b>PL:</b> Siły odrzutu, lanca <b>HU:</b> Visszaható erő, szórócső <b>RO:</b> Forțe de recul, tijă <b>BG:</b> Сили на откат, крайник. <b>RU:</b> Сила отдачи (распылитель). <b>ET:</b> Tagasilöögi jõud, otsik <b>LV:</b> Atsitiena spēks, smidzinātājs <b>LT:</b> Atatrankos jėga, antgalis, <b>JA:</b> 反跳力、ランス。 <b>ZH:</b> 反冲力 ( 喷杆 ) <b>KO:</b> 반동력, 랜스 <b>TH:</b> แรงสะท้อน ถอยหลัง, ปลાયทอ <b>MS:</b> Kuasa sentakan, lans. |
| 20 |                              | <b>L</b><br><b>л</b><br><b>升</b>                 | <b>EN:</b> Oil quantity, type. <b>DE:</b> Ölmenge, typ. <b>FR:</b> Quantité d'huile, type. <b>NL:</b> Hoeveelheid olie, type. <b>IT:</b> Quantità di olio, tipo. <b>NO:</b> Oljemengde, type. <b>SV:</b> Oljemängd, typ. <b>DA:</b> Oliemængde, type. <b>FI:</b> Öljymäärä, tyyppi. <b>ES:</b> Cantidad de aceite, tipo. <b>PT:</b> Quantidade de óleo, tipo. <b>EL:</b> Ποσότητα λαδιού, τύπος. <b>TR:</b> Yağ miktarı, tipi. <b>SL:</b> Količina olja, vrsta. <b>HR:</b> Količina ulja, vrsta. <b>SK:</b> Množstvo oleja, typ. <b>CS:</b> Množství oleje, typ. <b>PL:</b> Mnożstwo oleje, typ. <b>HU:</b> Olajmennyiség, típusa. <b>RO:</b> Cantitate de ulei, tip. <b>BG:</b> Количество масло, Тип. <b>RU:</b> Количество масла, Тип. <b>ET:</b> õli kogus, tüüp. <b>LV:</b> Eļļas daudzums, tips. <b>LT:</b> alyvos kiekis, tipas. <b>JA:</b> オイル量種類. <b>ZH:</b> 猴祇 类型 <b>KO:</b> 오일량, 유형. <b>TH:</b> ปริมาณน้ำมันเครื่อง ประเภท <b>MS:</b> Kuantiti minyak, jenis.  |
| 21 |                              | <b>kW</b><br><b>кВт</b>                          | <b>EN:</b> Heating capacity. <b>DE:</b> Heizleistung. <b>FR:</b> Puissance calorifique. <b>NL:</b> Verwarmingscapaciteit. <b>IT:</b> Potenza termica. <b>NO:</b> Varmekapasitet. <b>SV:</b> Värmeeffekt. <b>DA:</b> Opvarmningskapacitet. <b>FI:</b> Lämmitysteho. <b>ES:</b> Capacidad de calentamiento. <b>PT:</b> Capacidade de aquecimento. <b>EL:</b> Θερμική απόδοση. <b>TR:</b> Isıtma kapasitesi. <b>SL:</b> Zmogljivost gretja. <b>HR:</b> Kapacitet grijanja. <b>SK:</b> Ohrevný výkon. <b>CS:</b> Tepelný výkon. <b>PL:</b> Moc grzewcza. <b>HU:</b> Fűtőteljesítmény. <b>RO:</b> Capacitate de încălzire. <b>BG:</b> Отоплителна мощност. <b>RU:</b> Мощность нагрева. <b>ET:</b> Küttevõimsus. <b>LV:</b> Sildīšanas jauda. <b>LT:</b> Šildymo galia. <b>JA:</b> 加熱能力. <b>ZH:</b> 热容量. <b>KO:</b> 가열 용량. <b>TH:</b> ความจุความร้อน <b>MS:</b> Kapasiti pemanasan.  |

|    |  |             |  |
|----|--|-------------|--|
| 22 |   | L<br>л<br>升 | <p><b>EN:</b> Fuel tank. <b>DE:</b> Kraftstofftank. <b>FR:</b> Réservoir de carburant. <b>NL:</b> Brandstoftank. <b>IT:</b> Serbatoio carburante. <b>NO:</b> Drivstoffbeholder. <b>SV:</b> Bränsletank. <b>DA:</b> Brændstofftank. <b>FI:</b> Polttoainesäiliö. <b>ES:</b> Depósito de combustible. <b>PT:</b> Depósito de combustível. <b>EL:</b> Πεζερβουάρ καυσίμου. <b>TR:</b> Yakıt deposu. <b>SL:</b> Posoda za gorivo. <b>HR:</b> Spremnik goriva. <b>SK:</b> Palivová nádrž. <b>CS:</b> Palivová nádrž. <b>PL:</b> Zbiornik paliwa. <b>HU:</b> Üzemanyagtartály. <b>RO:</b> Rezervor de combustibil. <b>BG:</b> Резервоар за гориво. <b>RU:</b> Топливный бак. <b>ET:</b> Kütusepaak. <b>LV:</b> Degvielas tvertne. <b>LT:</b> Kuro bakas. <b>JA:</b> 燃料タンク。 <b>ZH:</b> 油箱。 <b>KO:</b> 연료 탱크. <b>TH:</b> ถังเชื้อเพลิง <b>MS:</b> Tangki bahan api.</p>  |
| 23 |   | L<br>л<br>升 | <p><b>EN:</b> Detergent tank A/B. <b>DE:</b> Reinigungsmittelbehälter A/B. <b>FR:</b> Réservoir de détergent A/B. <b>NL:</b> Reinigingsmiddeltank A/B. <b>IT:</b> Serbatoio del detergente A/B. <b>NO:</b> Vaskemiddelbeholder A/B. <b>SV:</b> Tank för rengöringsmedel A/B. <b>DA:</b> Rengøringsmiddeltank A/B. <b>FI:</b> Pesuainesäiliö A/B. <b>ES:</b> Depósito de detergente A/B. <b>PT:</b> Depósito de detergente A/B. <b>EL:</b> Πεζερβουάρ απορρυπαντικών A/B. <b>TR:</b> Deterjan deposu A/B. <b>SL:</b> Posoda za detergent A/B. <b>HR:</b> Spremnik za deterđent A/B. <b>SK:</b> Nádoaba na čistiaci prostriedok A/B. <b>CS:</b> Nádrž na čistící prostředek A/B. <b>PL:</b> Zbiornik na plyn do czyszczenia A/B. <b>HU:</b> Tisztítószerartály A/B. <b>RO:</b> Rezervor de detergent A/B. <b>BG:</b> Резервоар за почистващ препарат A/B. <b>RU:</b> Бак с моющим средством A/B. <b>ET:</b> Puhastusvahendi paak A/B. <b>LV:</b> Mazgāšanas līdzekļu tvertne A/B. <b>LT:</b> Ploviklio bakas A/B. <b>JA:</b> 洗剤タンクA/B。 <b>ZH:</b> 洗涤剂箱 A/B。 <b>KO:</b> 세제 탱크 A/B. <b>TH:</b> ถังสารซักฟอก A/B <b>MS:</b> Tangki detergent A/B.</p> |
| 24 | <p><b>EN:</b> Specifications and details are subject to change without prior notice. <b>DE:</b> Technische Daten und Details des Geräts können sich ohne vorherige Ankündigung ändern. <b>FR:</b> Ces spécifications et détails sont susceptibles d'être modifiés sans préavis. <b>NL:</b> Specificaties en details kunnen zonder voorafgaande waarschuwing worden gewijzigd. <b>IT:</b> Specifiche e dettagli sono soggetti a modifiche senza preavviso. <b>NO:</b> Spesifikasjonene og detaljene er gjenstand for endringer uten forutgående varsel. <b>SV:</b> Specifikationer och information kan ändras utan föregående meddelande. <b>DA:</b> Ret til ændringer i konstruktion og specifikationer forbeholdes. <b>FI:</b> Rakenteeseen ja teknisiin tietoihin voidaan tehdä muutoksia ilmoittamatta niistä ennalta. <b>ES:</b> Las especificaciones y los datos están sujetos a cambios sin previo aviso. <b>PT:</b> As especificações e os detalhes estão sujeitos a alterações sem aviso prévio. <b>EL:</b> Τα τεχνικά χαρακτηριστικά και οι λεπτομέρειες υπόκεινται σε αλλαγές χωρίς προηγούμενη ειδοποίηση. <b>TR:</b> Özellikler ve ayrıntılar, önceden haber verilmeden değiştirilebilir. <b>SL:</b> Tehnični podatki in podrobnosti se lahko spremenijo brez predhodnega obvestila. <b>HR:</b> Specifikacije i detalji mogu se mijenjati bez prethodne najave. <b>SK:</b> Špecifikácie a podrobnosti sa môžu meniť bez predchádzajúceho upozornenia. <b>CS:</b> Technické údaje a detaily mohou být změněny i bez předchozího upozornění. <b>PL:</b> Specyfikacje i parametry mogą zostać zmienione bez uprzedzenia. <b>HU:</b> A műszaki adatok és részletek előzetes értesítés nélkül megváltozhatnak. <b>RO:</b> Specificațiile și detaliile pot fi modificate fără înștiințare prealabilă. <b>BG:</b> Спецификациите и детайлите подлежат на промяна без предварително уведомление. <b>RU:</b> Технические характеристики и данные могут изменяться без предварительного извещения. <b>ET:</b> Tehnilisi kirjeldusi ja üksikasju võidakse muuta eelneva etteteatamiseta. <b>LV:</b> Specifikācijas un detaļas var tikt mainītas bez iepriekšēja paziņojuma. <b>LT:</b> Konstrukcija ir specifikacijos gali keistis be išankstinio įspėjimo. <b>JA:</b> 仕様および情報は事前通知無しに変更する場合があります。 <b>ZH:</b> 规格和详情如有变更，恕不另行通知。 <b>KO:</b> 사양 및 내용은 예고없이 변경될 수 있습니다. <b>TH:</b> ข้อกำหนดเฉพาะและรายละเอียดสามารถเปลี่ยนแปลงได้โดยไม่ต้องแจ้งให้ทราบล่วงหน้า <b>MS:</b> Spesifikasi dan butiran adalah tertakluk kepada perubahan tanpa notis terlebih dahulu.</p> |             |  |

 **Nilfisk**<sup>®</sup>

 07351-5758060

[kontakt@nilfisk-alto-shop.com](mailto:kontakt@nilfisk-alto-shop.com)



 **Heine**  
Vertriebs-GmbH

**Preisabfrage bzw. Bestellungen der Artikel im Shop unter**

**[www.nilfisk-alto-shop.com](http://www.nilfisk-alto-shop.com)**

**einfach die Artikelnummer in die Suchmaske eingeben**

**(Bitte die Artikelnummer ohne Leerzeichen eingeben)**