

PARTS LIST



2020.10.22

TABLE OF CONTENTS

L140 - 1 - CAR	1
L140 - 2 - CAR	3
L140 - 3 - CAR	5
L140 - 4 - CONTAINER UNIT	7
L140 - 5 - CONTAINER UNIT	9
L140 - 6 - FILTER GROUP	11
L140 - 7 - ABSOLUTE FILTER	13
L140 - 8 - SUCTION UNIT	15
L140 - 9 - SUCTION UNIT	17
L140 - 10 - SUCTION UNIT	19
L140 - 11 - SUCTION UNIT	21
L140 - 12 - SUCTION UNIT	23
L140 - 13 - SUCTION UNIT	25
L140 - 14 - SUCTION UNIT	27
L140 - 15 - SUCTION UNIT	29
L140 - 16 - SUCTION UNIT	31
L140 - 17 - SUCTION UNIT	33
L140 - 18 - CYCLON KIT	35
L140 - 19 - GRID GROUP	37
L140 - 20 - GRID AND DEPRESSOR	39
L140 - 21 - CAPACITIVE GROUP	41

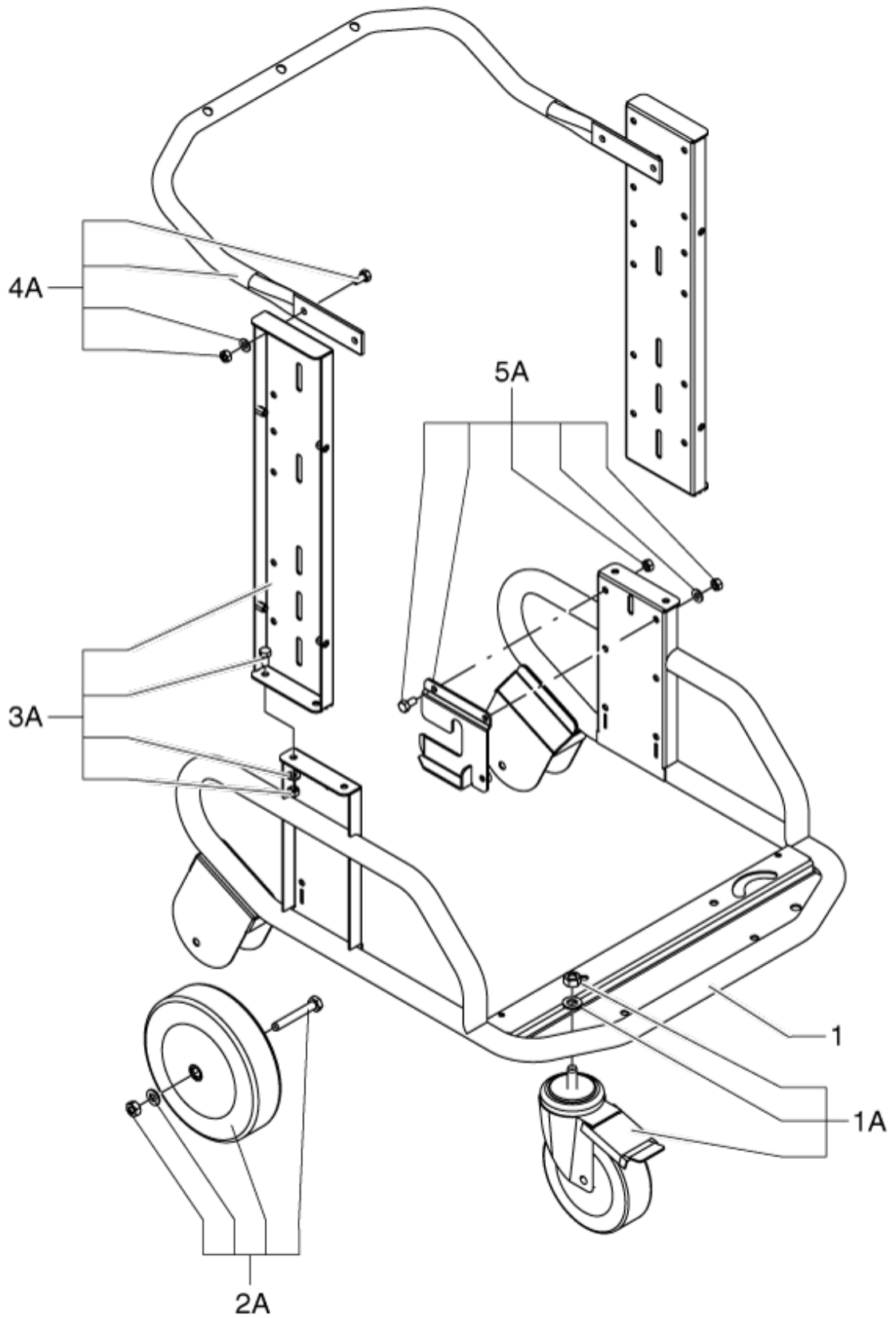

Pos.	Artikel-Nr.	Menge	Variante	Notes
1	4083600611	1	TROLLEY FOR MODEL S2-S3 R7016	
1A	40000874	1	KIT REVOLV. CASTOR D150	
2A	40000873	1	Rad D200 Kit	
3A	40000871	1	UPRIGHT KIT	
4A	40000891	1	HANDLE KIT	
5A	40000872	1	Befestigungskit	

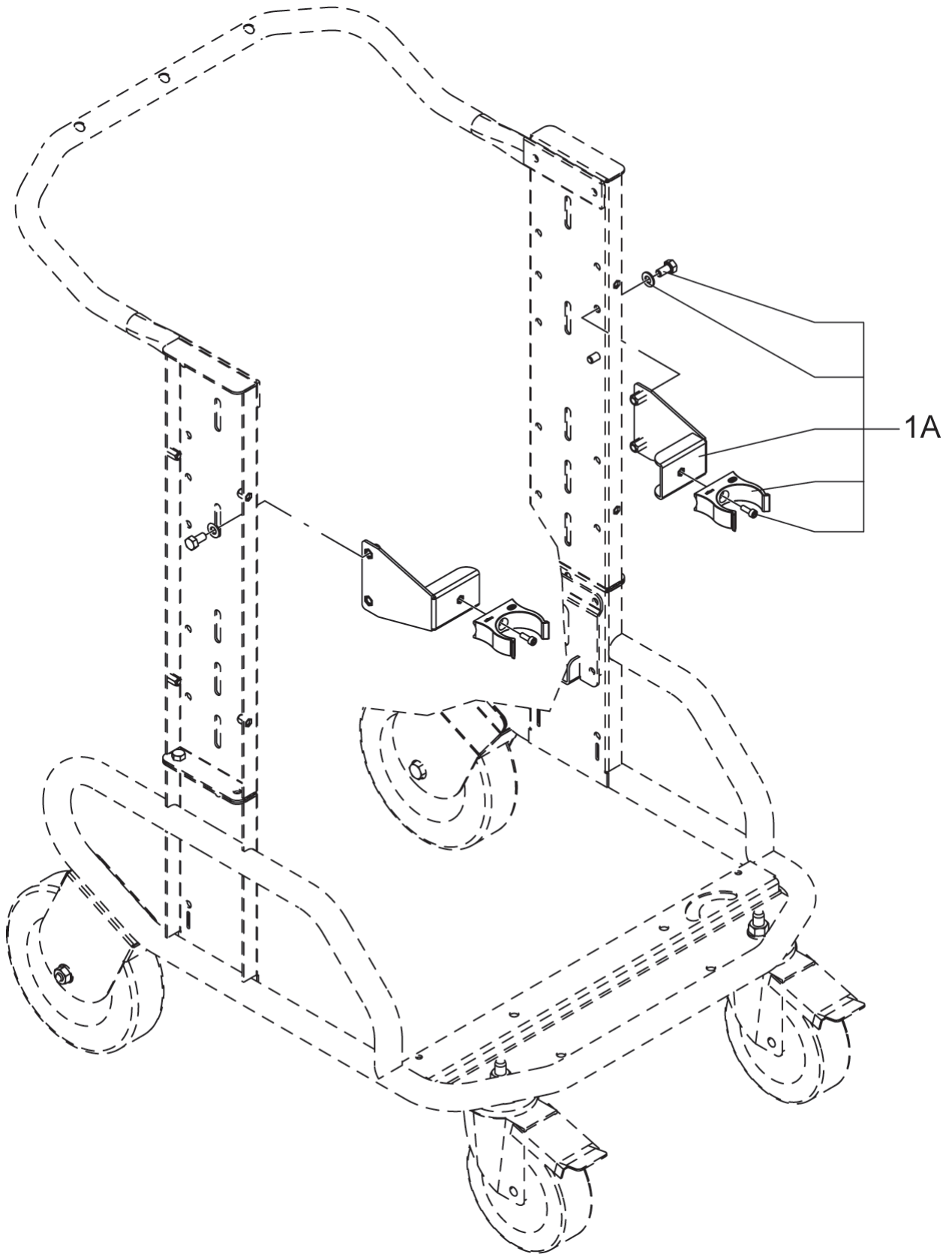

Pos.	Artikel-Nr.	Menge	Variante	Notes
1A	40000856	1	Schlauchhalter	

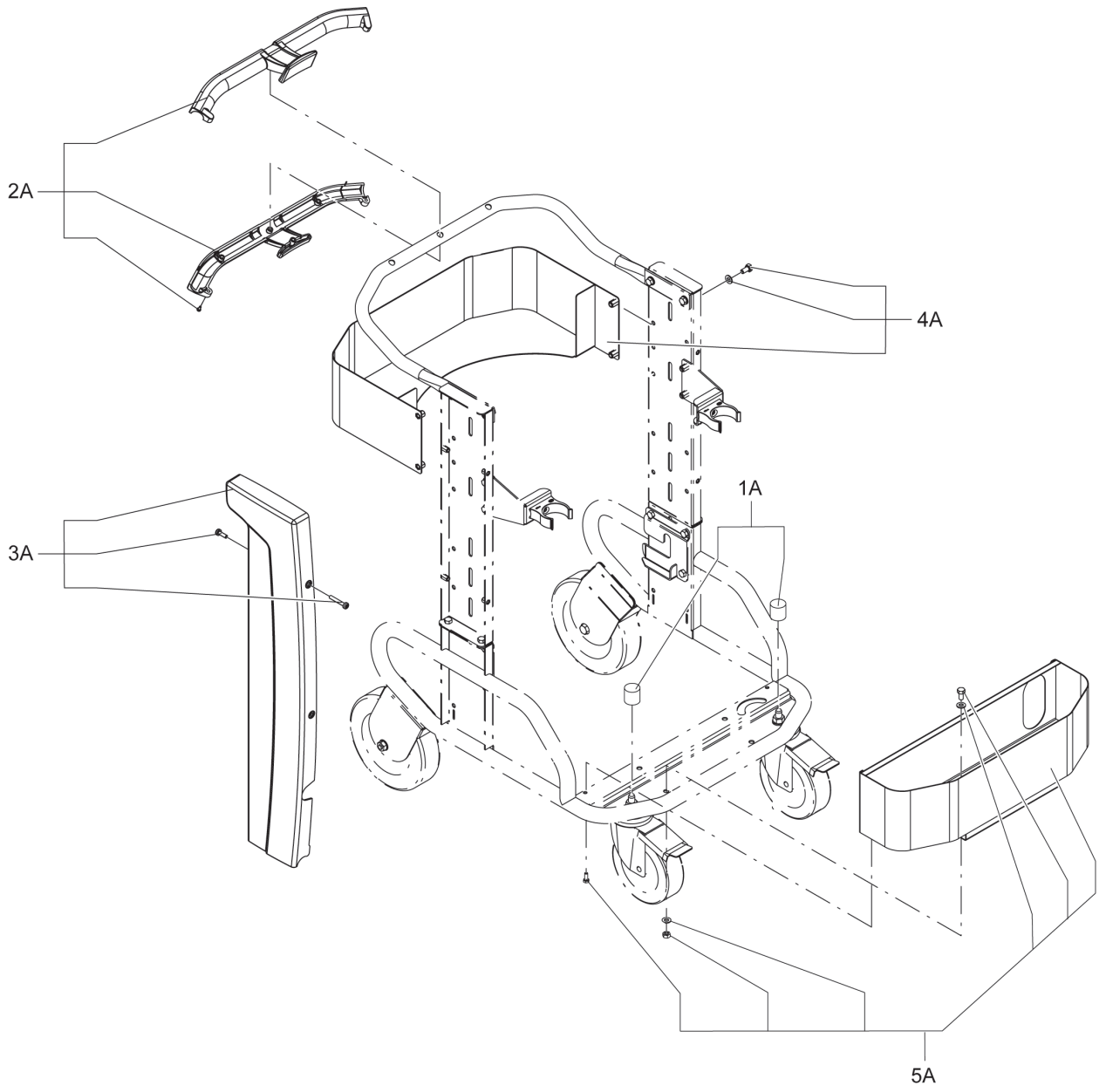

Pos.	Artikel-Nr.	Menge	Variante	Notes
1A	40000870	1	Schutzhelme - Kit	
2A	40000855	1	Griffkit	
3A	40000864	1	Verkleidung	
4A	40000893	1	Zubehörkorb Kit	
5A	40000892	1	Zubehörkorb Kit	

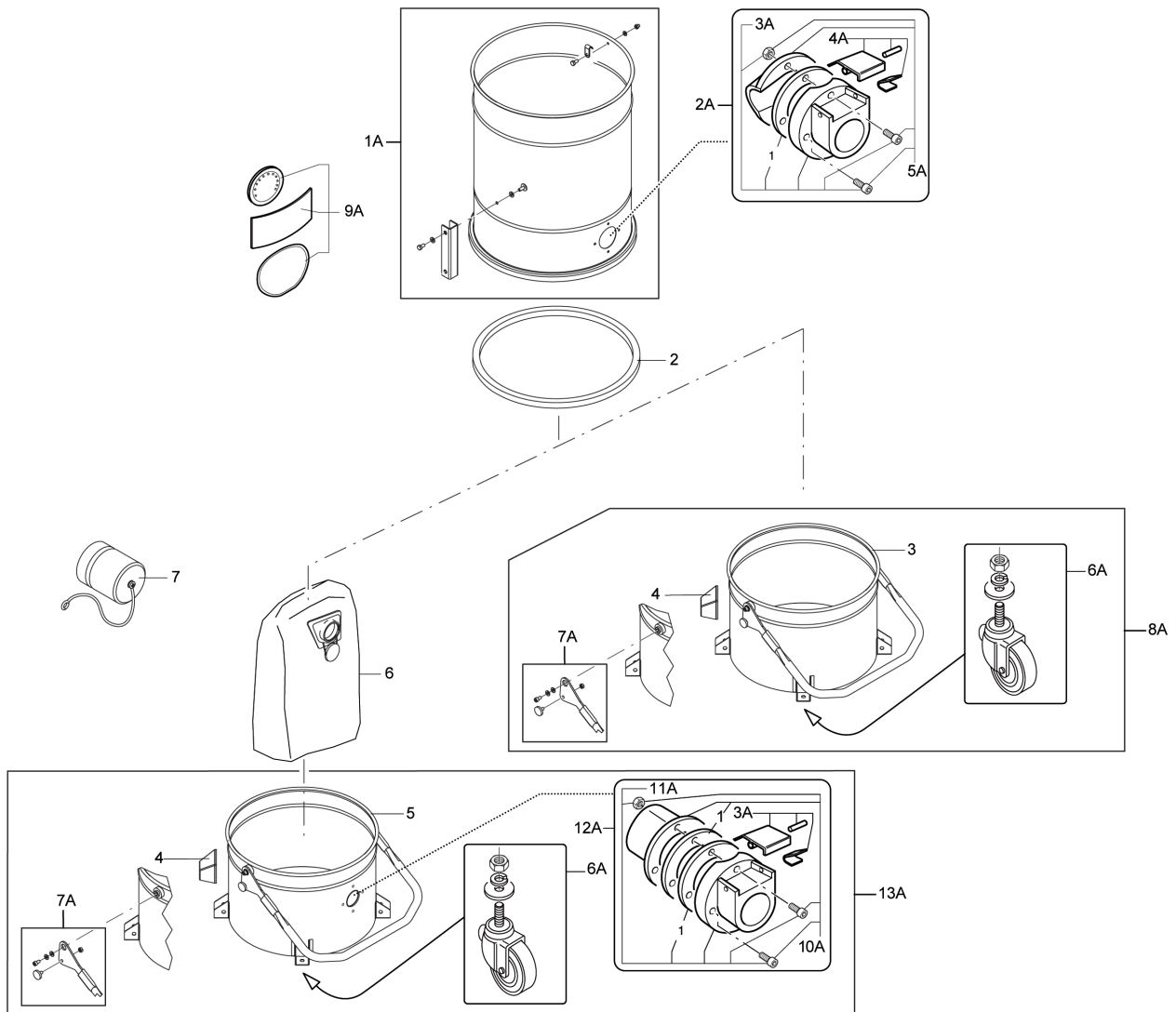

Pos.	Artikel-Nr.	Menge	Variante	Notes
1	8 17006	3	SEAL	
2	4081701540	1	SEAL 20 X 15 T140 CR MT1.5	
3	4083000529	1	BIN D460 L40 SS M.S2	[1]
3	4083000493	1	Kessel D460 L50 MODEL S2-S3	
3	4083000495	1	Behälter 100 L	
3	4083000509	1	BIN D460 L100 IN SS M.S3	
3	4083000526	1	BIN D460 L40 M.S2	[1]
4	8 17021	4	BUMPER	
5	4083000512	1	Staubkessel D460 L50	
5	4083000531	1	CONTENITORE D460 L40 FORO D70 ATTACCO SA	
5	4083000514	1	BIN D460 L50 FOR BAG ATTACK M.S3 SS	[1]
6	4084001244	1	Sicherheitsfiltersack 460mm	
7	7 21070	2	PLUG	
7	7 21072	2	PLUG INOX	
1A	40000895	1	STAIN LESS FILTER CHAMBER KIT	
1A	40000869	1	Filterkit	
2A	40000418	1	Kesselanschluß D70, kpl.	
2A	40000868	1	Anschluss D70	
3A	40000867	1	D70 INLET KIT	
3A	40000344	1	KIT INLET INOX D70	
4A	40000345	1	KIT PUSHBUTTON FOR INLET D70	
5A	40000395	1	KIT DEFLECTOR D70	
5A	40000416	1	KIT DEFLECTOR D70 INOX MOD.A17	
6A	40000419	1	Rad Kit zu 100l Kübel 4 Stk.	
6A	40000484	1	Rad, Edelstahl	
7A	40000924	1	HANDLE KIT L40	
7A	40000866	1	Griff für Staubkessel 50lt	
7A	40000879	1	Handgriff Kit	
7A	40000925	1	STAIN LESS HANDLE KIT L40	
8A	4083000530	1	COMPLETE BIN D460 L40 SS S2	
8A	4083000496	1	Behälter kpl. 50ltr.S2-S3	
8A	4083000497	1	Behälter kpl. D460 100l	
8A	4083000507	1	Schmutzbehälter 50L	
8A	4083000510	1	COMPLETE BIN D460 L100 SS	
8A	4083000527	1	COMPLETE BIN D460 L40 M.S2	
9A	40000896	1	Aufkleber	[1]
10A	40000852	1	DEFLECTOR FOR PAPER BAG KIT	
11A	40000867	1	D70 INLET KIT	
12A	40000894	1	D70 INLET FULL KIT	
13A	4056000474	1	KIT DISPOSAL SYSTEM D460 L50 MOD. S3	
13A	4056000475	1	KIT DISPOSAL SYSTEM D460 L50 I MOD.S3	
13A	4056000494	1	Entsorgungssystem d460 L40 S2	

Part Notes:

[1] - CONTACT PM IN ZOCCA

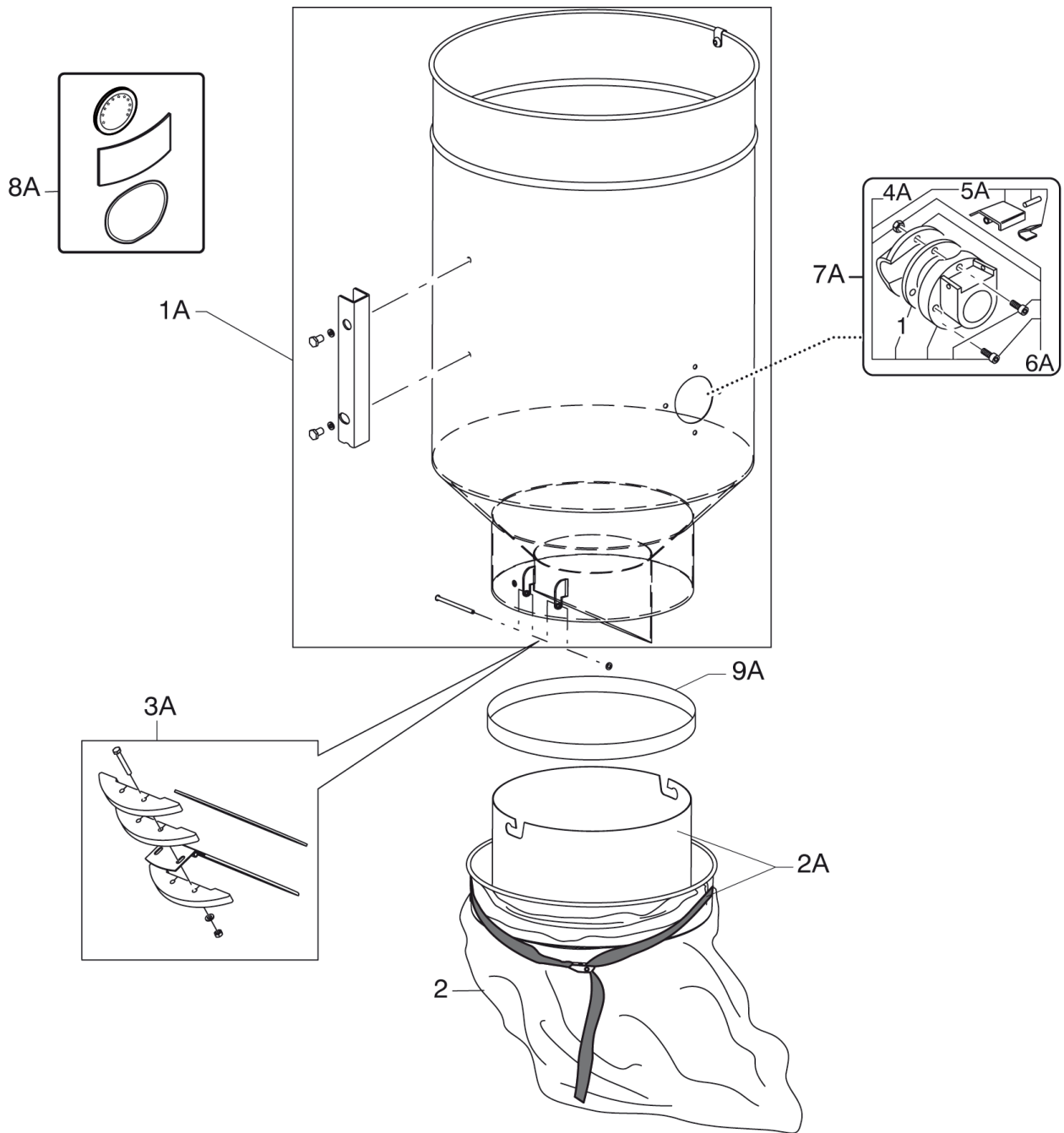

Pos.	Artikel-Nr.	Menge	Variante	Notes
1	8 17006	3	SEAL	
2	4084000956	1	Ersatzbeutel - 4 x 20 m	
1A	4089101067	1	LP HOPPER KIT D460	
2A	4089100436	1	BAG HOLDER KIT	
3A	4089100437	1	CLAPET CLOSING KIT	
4A	40000867	1	D70 INLET KIT	
5A	40000345	1	KIT PUSHBUTTON FOR INLET D70	
6A	40000395	1	KIT DEFLECTOR D70	
7A	40000868	1	Anschluss D70	
8A	40000985	1	STICKER KIT	
9A	4089100872	1	KIT ADHESIVE SEAL 25X3	

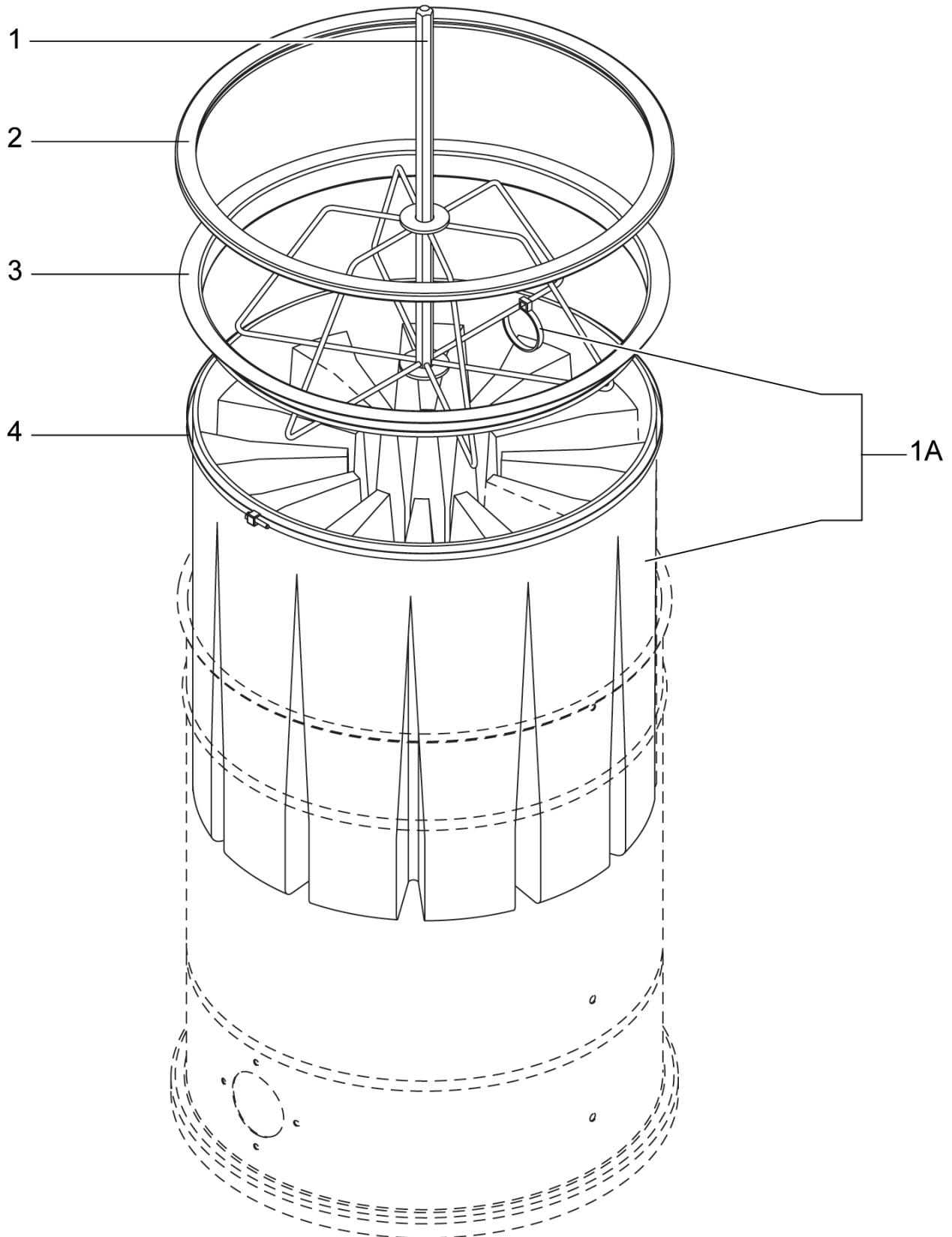

Pos.	Artikel-Nr.	Menge	Variante	Notes
1	4083300358	1	FILTER SHAKER CAGE FE D460 M. S2-S3	
1	4083300448	1	FILTER SHAKER CAGE ELECT.D460 M. S2-S3	[1]
2	Z8 17026	1	Dichtung ¥ 460	
2	Z8 17126	1	Filterringdichtung aus	
3	Z8 15003	1	Ring ¥460	
3	Z8 15010	1	Filterring D460 V2A	
4	Z8 18079	1	Filter Halter ¥ 460	
1A	40000492	1	Sternfilter Ø460mm Polyester, M-Klasse	
1A	40000338	1	Sternfilter Ø460mm Polyester, L-Klasse	
1A	40000898	1	Sternfilter Ø460mm Nomex®	
1A	32400327	1	Filter PTFE M zu IV 040	[1]

Part Notes:

[1] - CONTACT PM IN ZOCCA

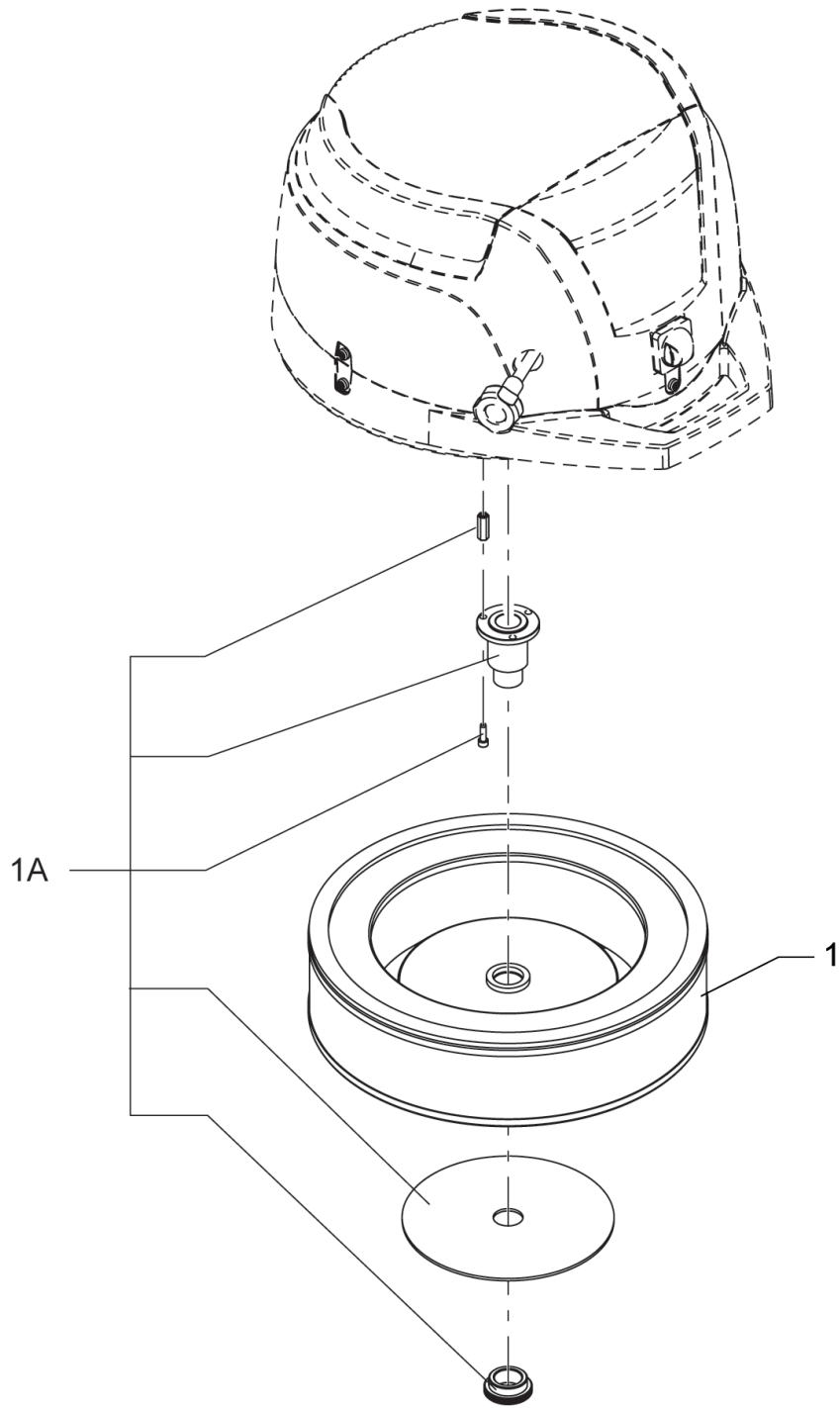

Pos.	Artikel-Nr.	Menge	Variante	Notes
1	4081700936	1	Absolutfilter AU 415 x 100	
1	4081700935	1	Absolutfilter AU 415 x 100	
1A	40000897	1	AU-Filter Montage-Kit	

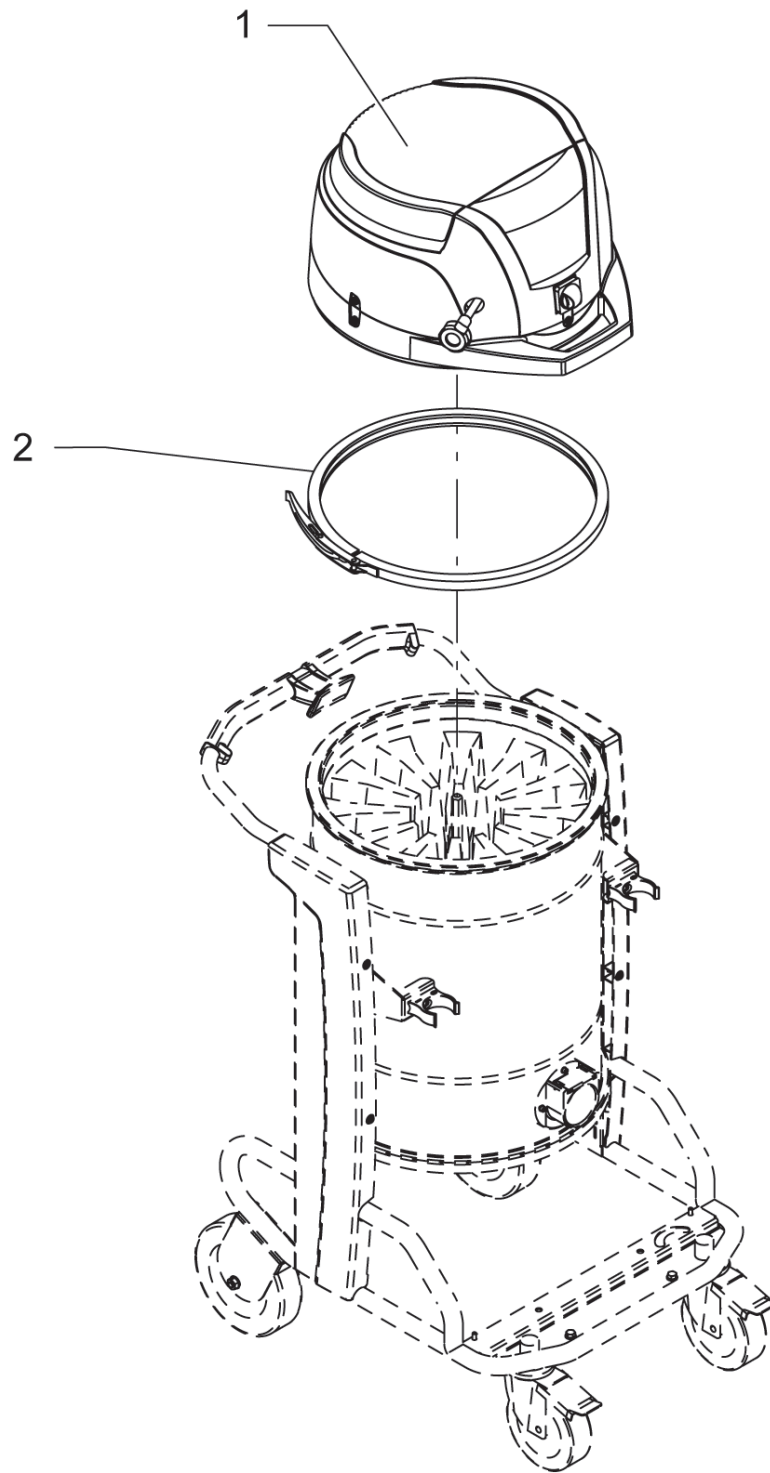

Pos.	Artikel-Nr.	Menge	Variante	Notes
1	4085300331	1	COMPLETE HEAD S3 230V EU	
1	4085300333	1	COMPLETE HEAD S3 230V UK	
1	4085300335	1	COMPLETE HEAD S3 110V UK	
1	4085300349	1	EL FILTER SHAKER S3 230V EU HEAD	
1	4085300350	1	EL FILTER SHAKER S3 230V UK HEAD	
1	4085300351	1	EL FILTER SHAKER S3 110V UK HEAD	
1	4085300332	1	COMPLETE HEAD S2 230V EU	
1	4085300334	1	COMPLETE HEAD S2 230V UK	
1	4085300336	1	COMPLETE HEAD S2 110V UK	
1	4085300346	1	EL.FILTER SHAKER S2 230V EU HEAD	
2	8 36191	1	GASKET 460MM	
2	8 36355	1		

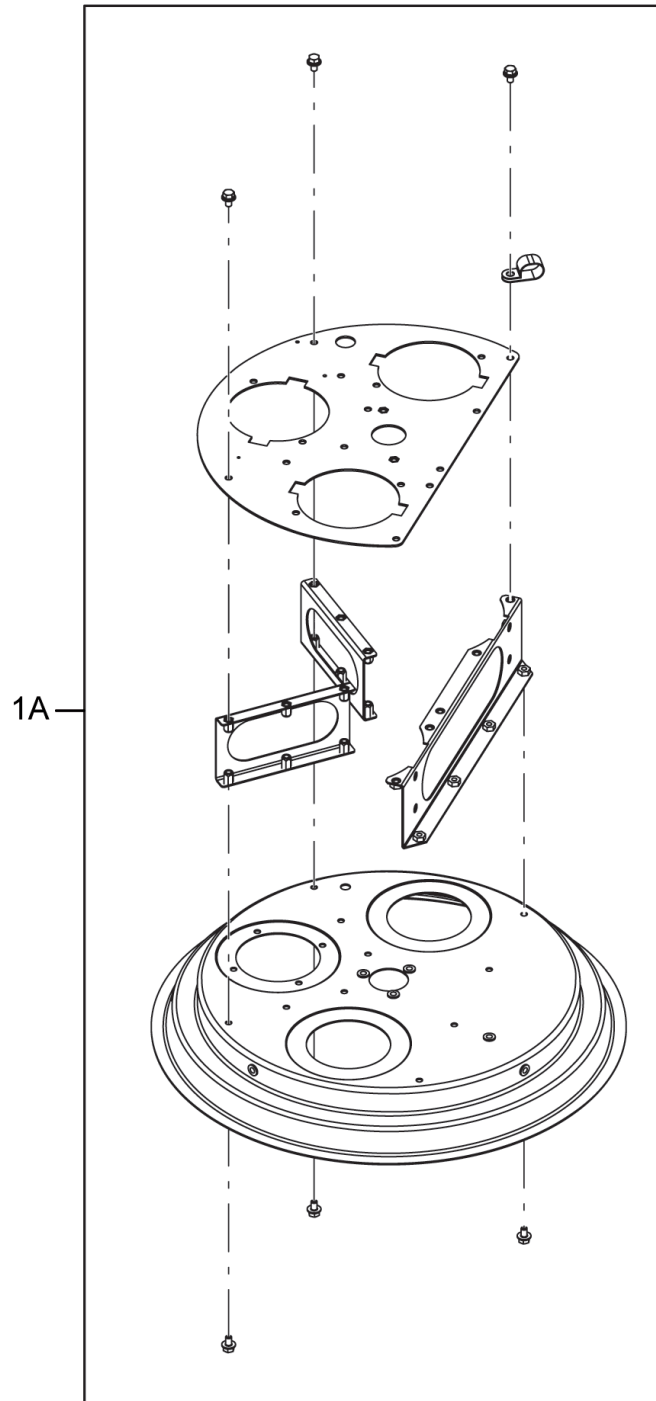

Pos.	Artikel-Nr.	Menge	Variante	Notes
1A	40000899	1	MOTOR SUPPORT KIT	

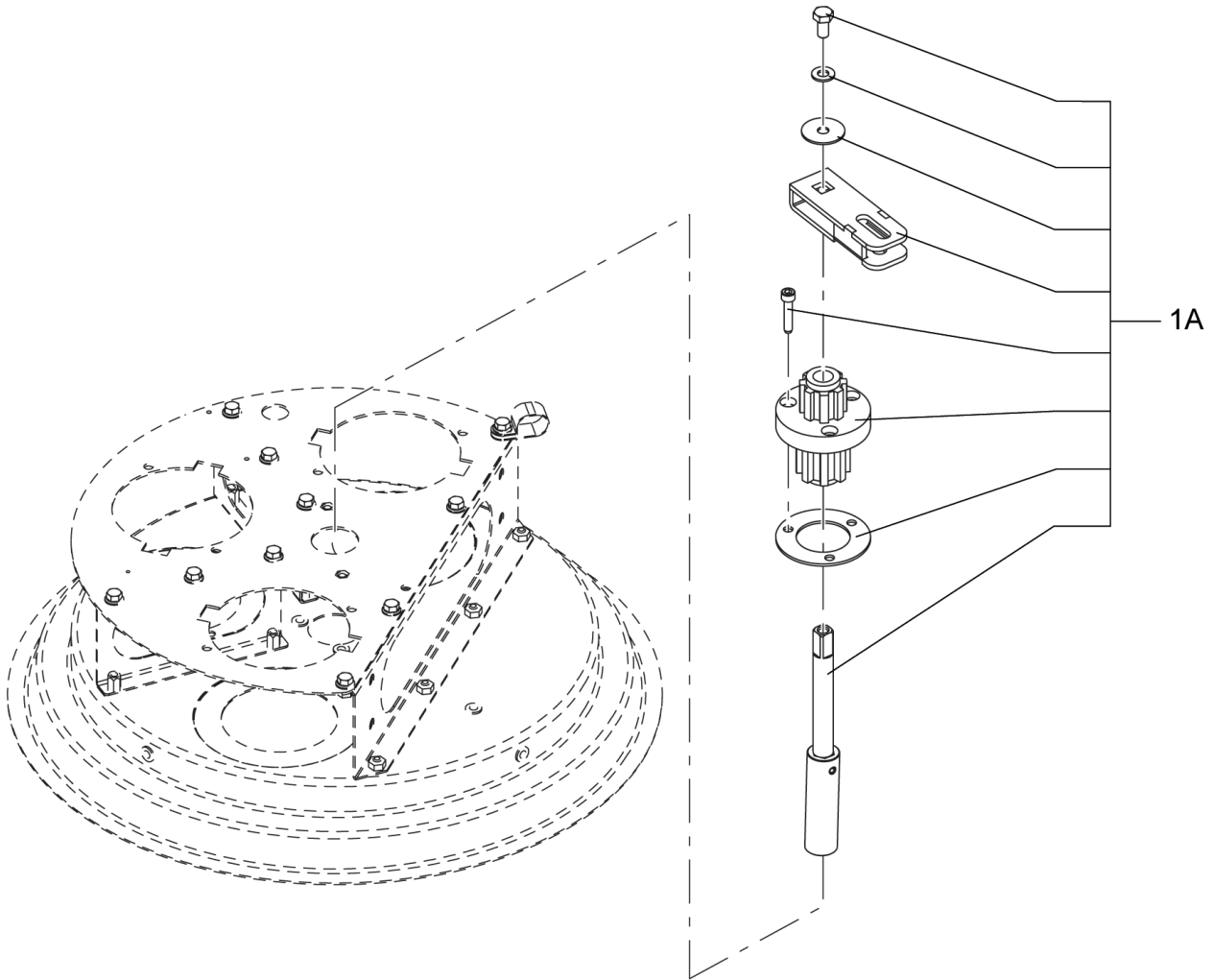

Pos.	Artikel-Nr.	Menge	Variante	Notes
1A	40000900	1	Zwischenteil für	

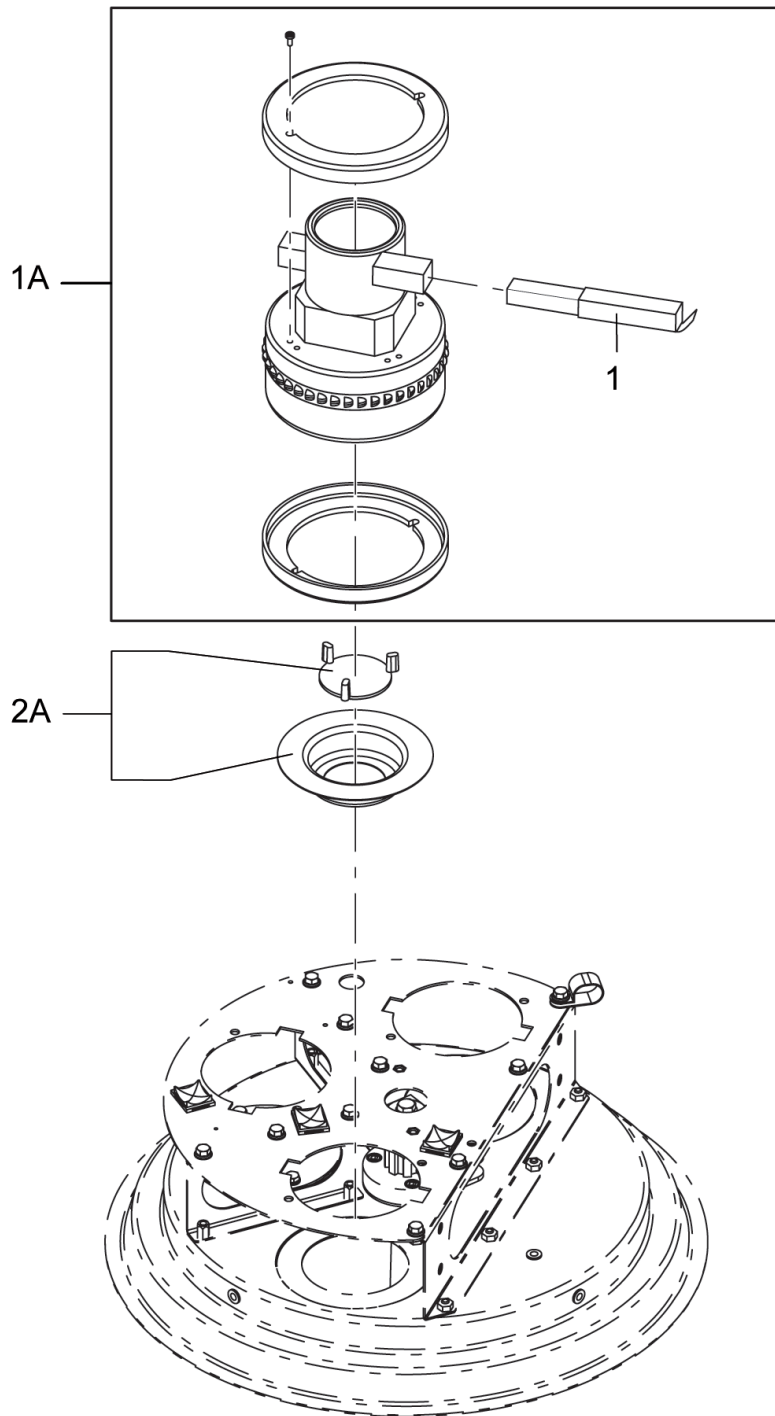

Pos.	Artikel-Nr.	Menge	Variante	Notes
1	40000885	1	MOTOR BRUSH KIT V230	
1	40000886	1	MOTOR BRUSH KIT V120	
1A	40000937	1	Motor Kit V230	
1A	40000938	1	MOTOR KIT V110 UK	
2A	40000902	1	Drosselventil	

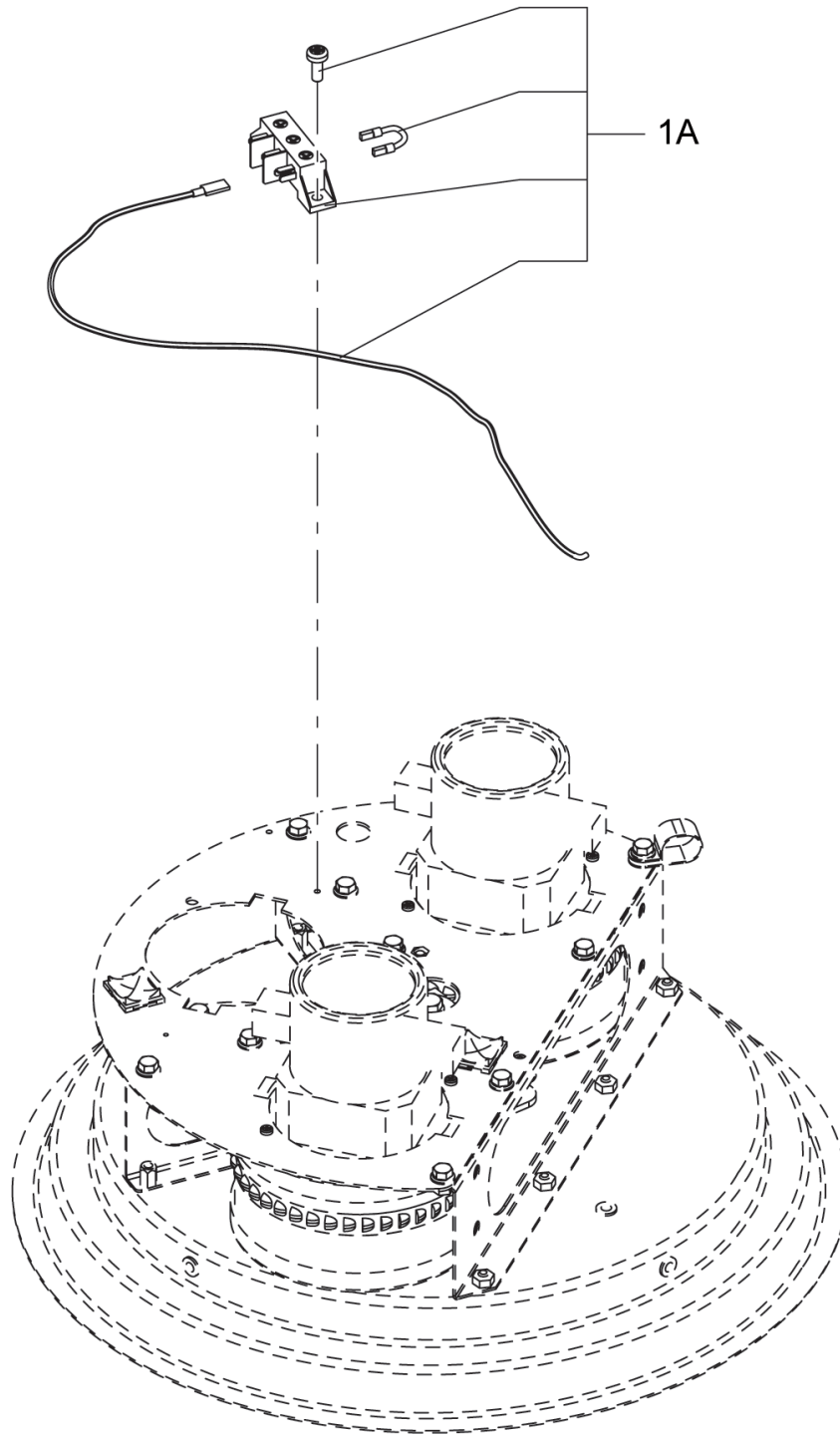

Pos.	Artikel-Nr.	Menge	Variante	Notes
1A	40000905	1	CABLE KIT FOR MOTORHEAD	

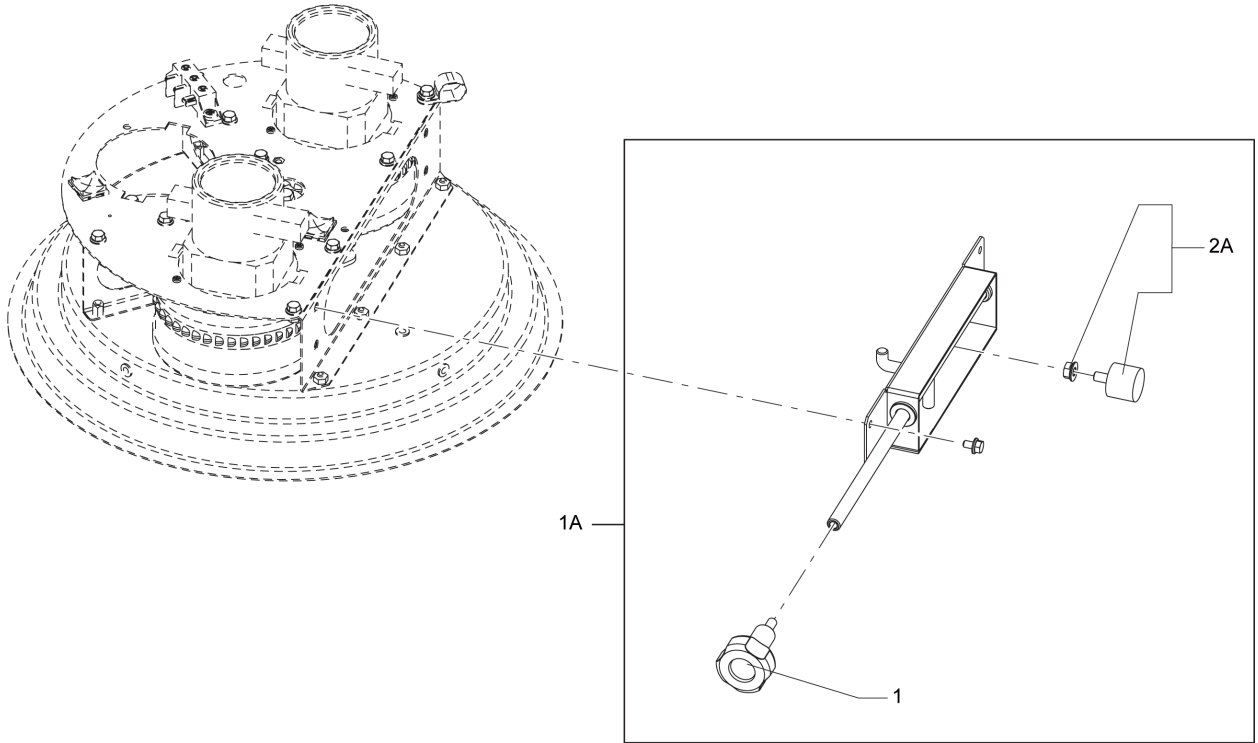

Pos.	Artikel-Nr.	Menge	Variante	Notes
1	4084001012	1	Griffknopf für Schüttel-	
1A	40000906	1	FILTERSHAKER KIT	
2A	40000907	1	PUFFER KIT	[1]

Part Notes:

[1] - CONTACT PM IN ZOCCA

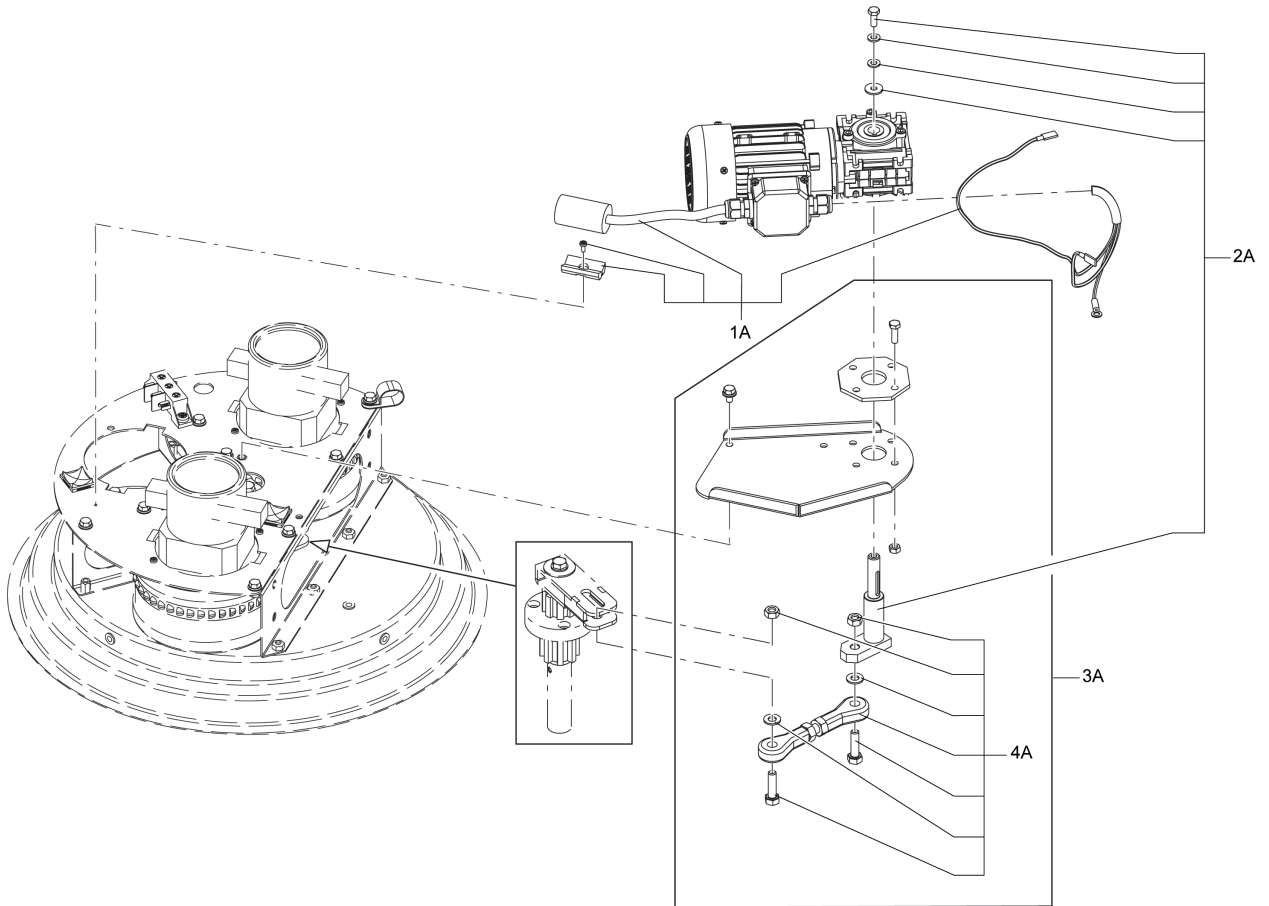

Pos.	Artikel-Nr.	Menge	Variante	Notes
1A	4085600142	1	MOTORREDUCERXSE D460 S2-S3	
1A	4085600143	1	MOTOR RED.SE D460 M.S2-S3V110 UK	[1]
2A	40000920	1	GEARMOTOR SHAFT KIT	[1]
3A	40000918	1	GEARMOTOR FIXING KIT	
4A	40000919	1	FILTERSHAKER JOINT KIT	

Part Notes:

[1] - CONTACT PM IN ZOCCA

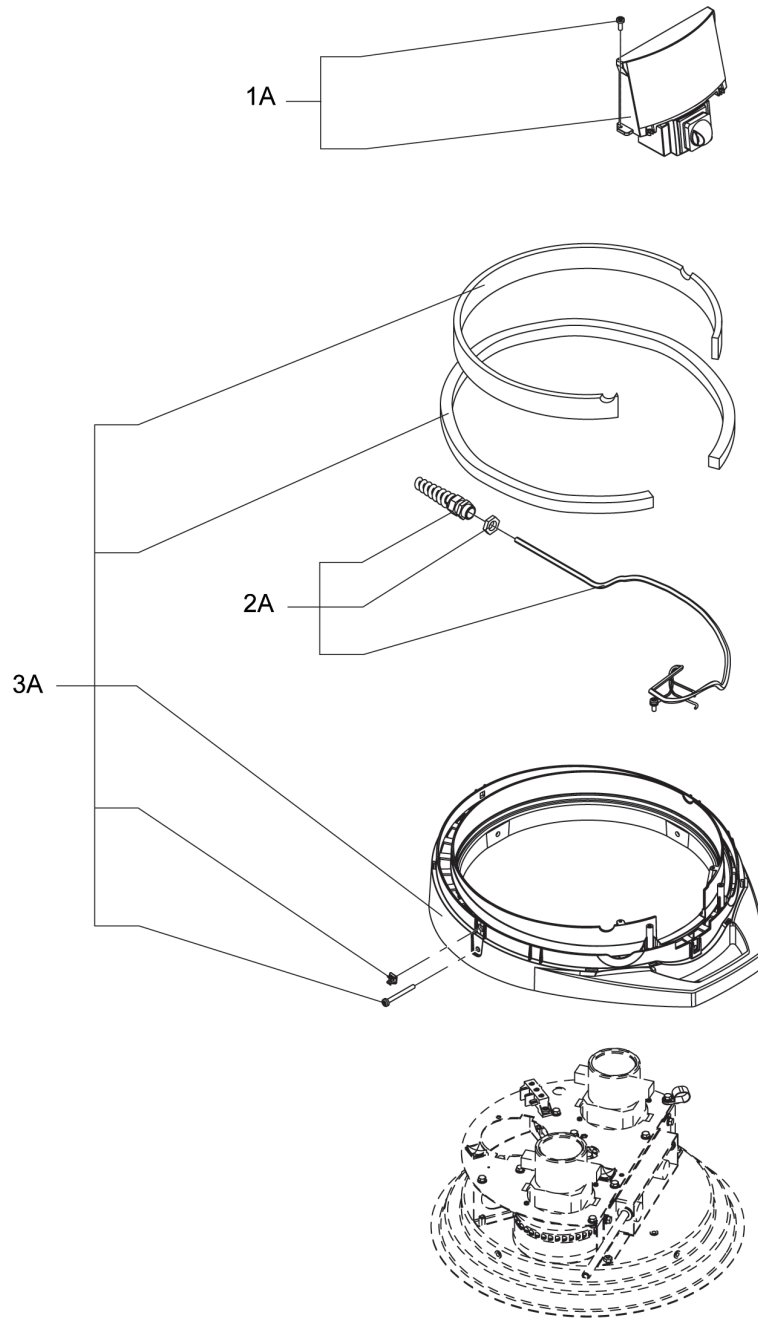

Pos.	Artikel-Nr.	Menge	Variante	Notes
1A	40000922	1	KEYBOARD KIT 3 MOTORS 110V UK	
1A	40000921	1	KEYBOARD KIT 3 MOTORS 230V	
1A	40000912	1	Bedientastatur	
1A	40000911	1	KEYBOARD KIT 2 MOTORS 110V UK	[1]
2A	40000913	1	CABLE KIT V230 UK	
2A	40000909	1	Kabel-Kit 230V EU	
2A	40000910	1	S2B CABLE KIT V110 UK	
2A	4083901895	1	CAVO ALIM. 3G1.5 NEOP. SP.10A CHP	
3A	40000908	1	Luftverteiler	

Part Notes:

[1] - CONTACT PM IN ZOCCA

1A

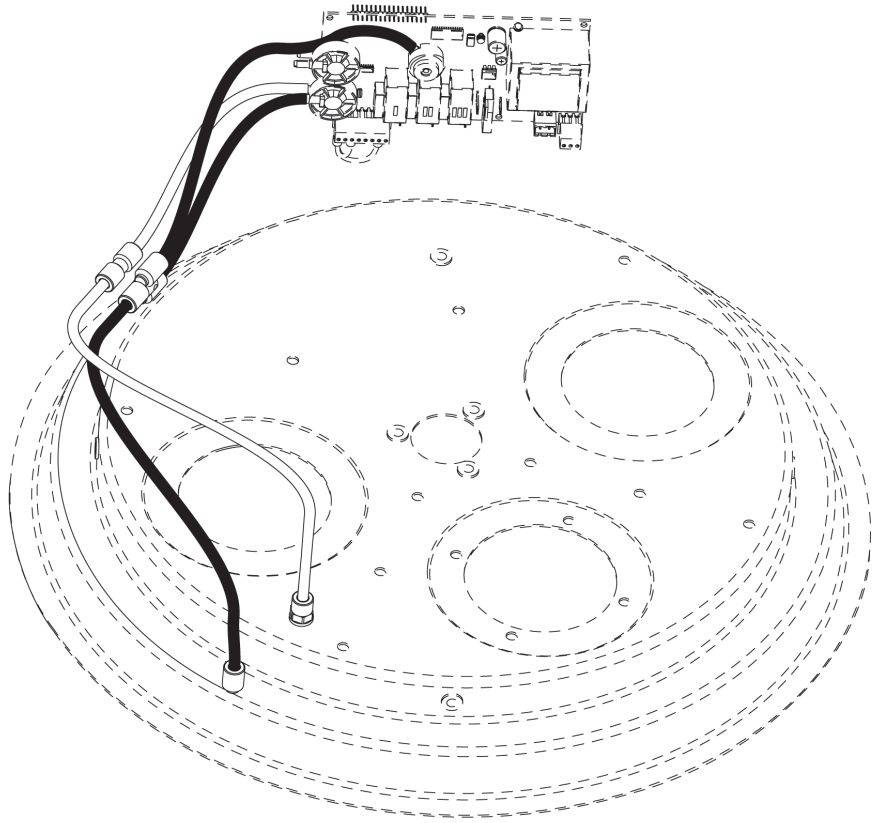
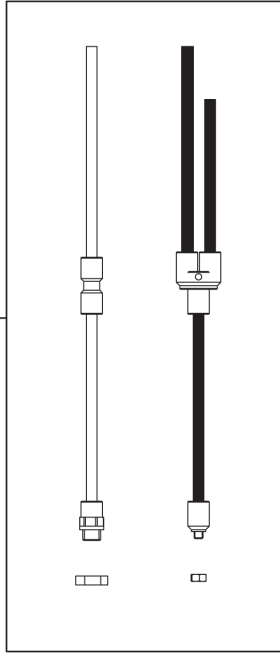

Pos.	Artikel-Nr.	Menge	Variante	Notes
1A	40000914	1	FILTER SENSOR HOSE KIT	

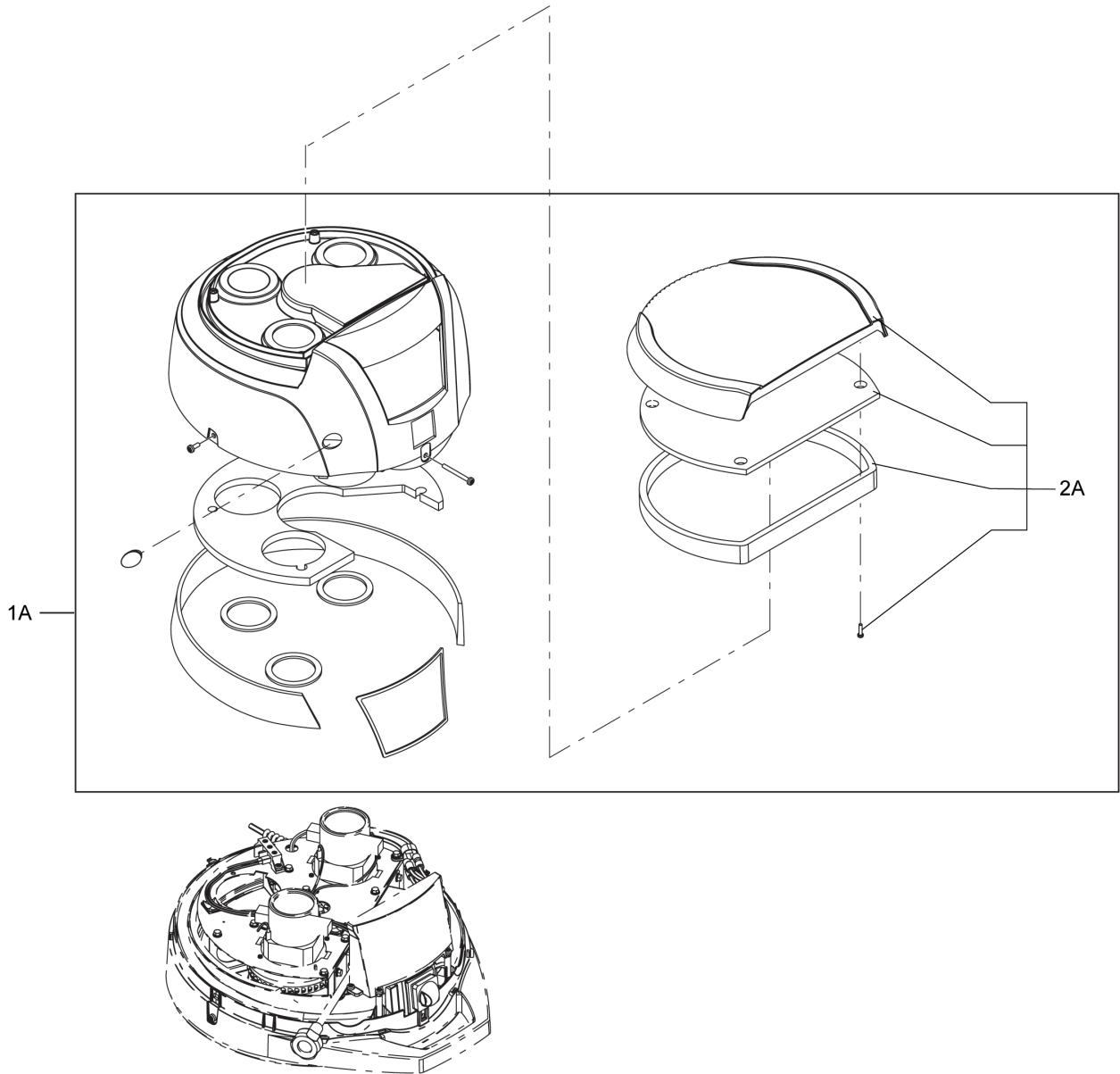

Pos.	Artikel-Nr.	Menge	Variante	Notes
1A	40000917	1	Deckelkit	
2A	40000916	1	Kit Abdeckung Lufteinzug	

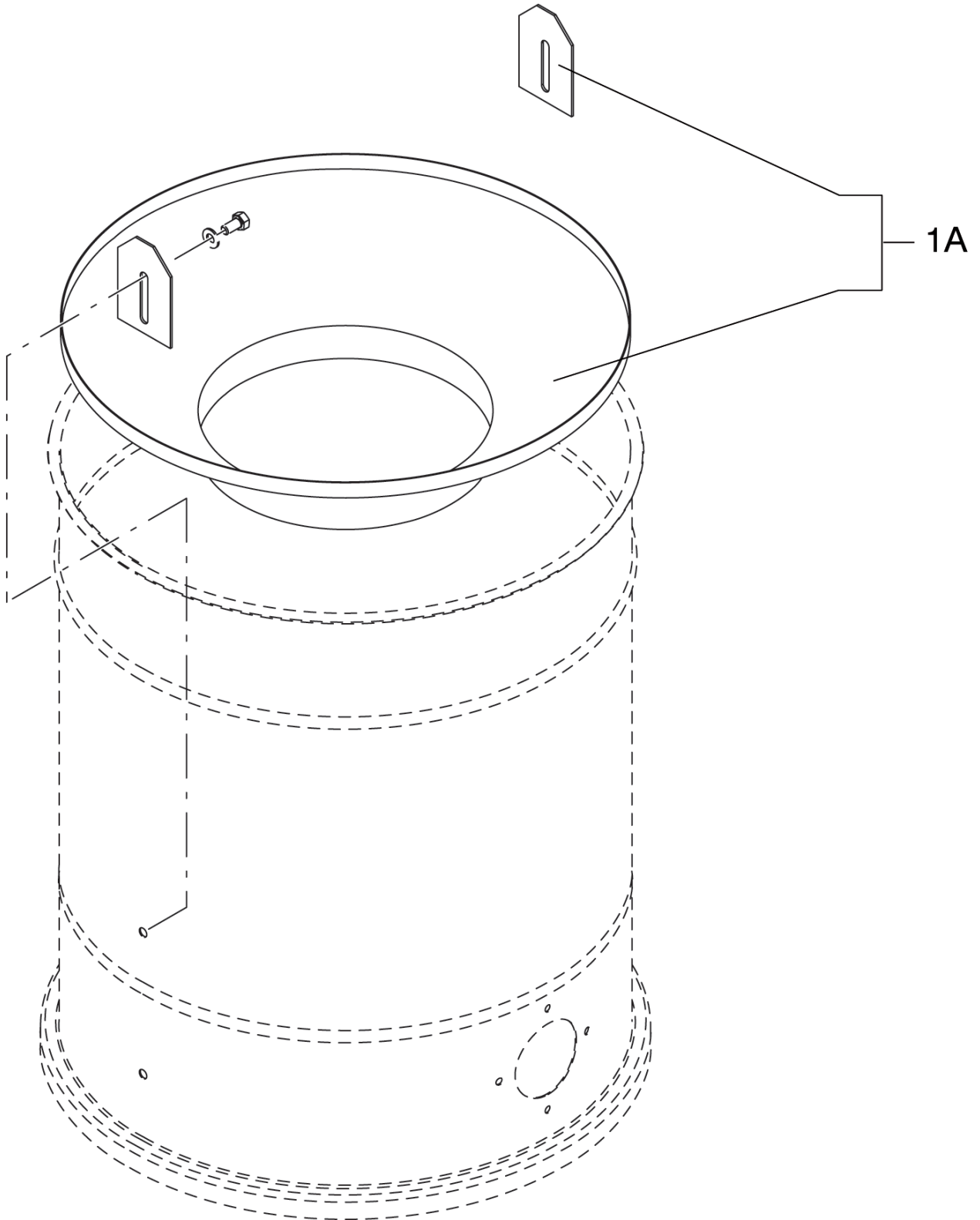

Pos.	Artikel-Nr.	Menge	Variante	Notes
1A	Z5 60109	1	Zyklon und Halteklammern Ø460;Stahl vz	

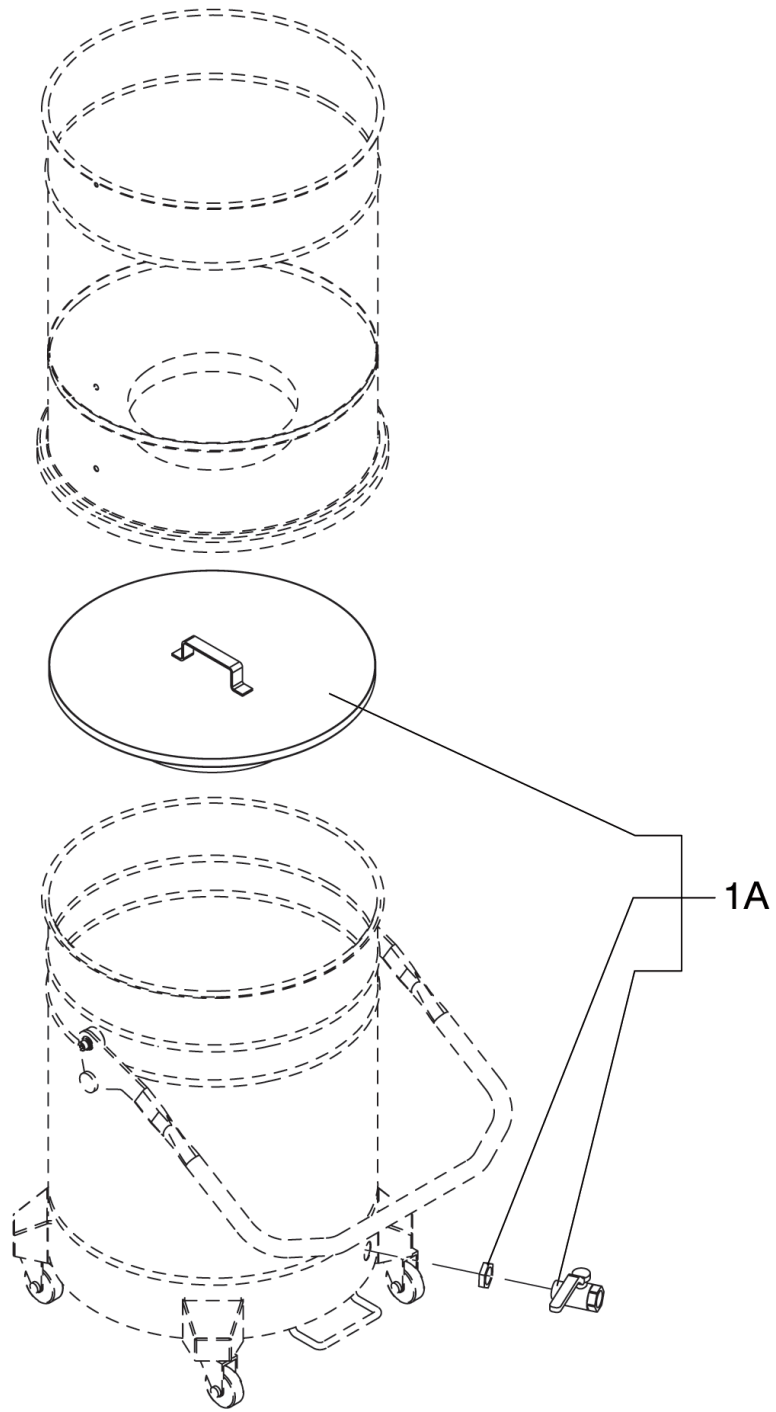

Pos.	Artikel-Nr.	Menge	Variante	Notes
1A	Z5 60034	1	Spänesieb mit Ablasshahn Ø460;Stahl vz	

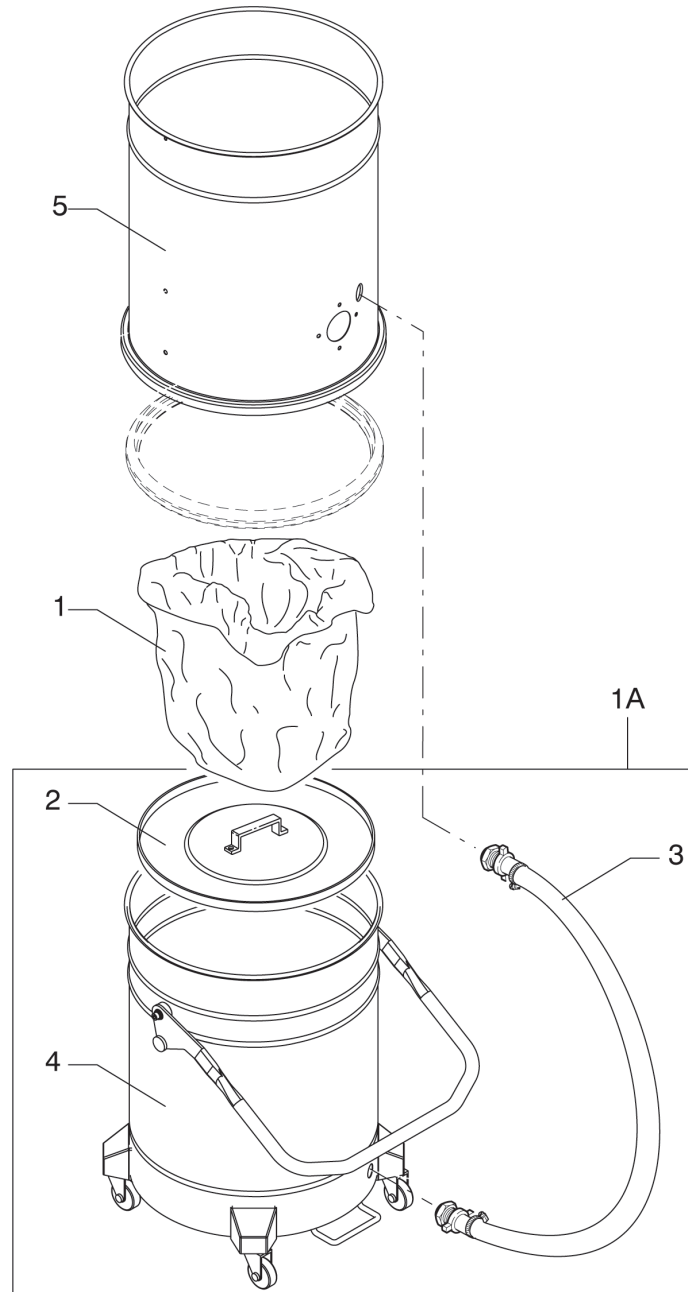

Pos.	Artikel-Nr.	Menge	Variante	Notes
1	Z8 40100	1	Entsorgungssäcke Polyethylen Ø460 - 560	
2	Z8 31221	1	Siebeinsatz D460FE	[1]
3	Z5 60272	1	KIT TUBE LEVEL CHECK LT.100 COMPLETE	[1]
4	4083000552	1	BIN D460 S3 L100 GRILL AND DEP	[1]
4	4083000561	1	CONTENIT.D460L50XM.S2-S3F.DEPR R7001	
4	4083000663	1	CONTENITORE D460 L40 X M.S2 F.DEPR R7001	
5	4083100992	1	LATERALE D460X590 M.S2-S3F.DEPR R7001	
1A	4056000535	1	Plastiksackentleerung Ø460;Stahl vz	

Part Notes:

[1] - CONTACT PM IN ZOCCA

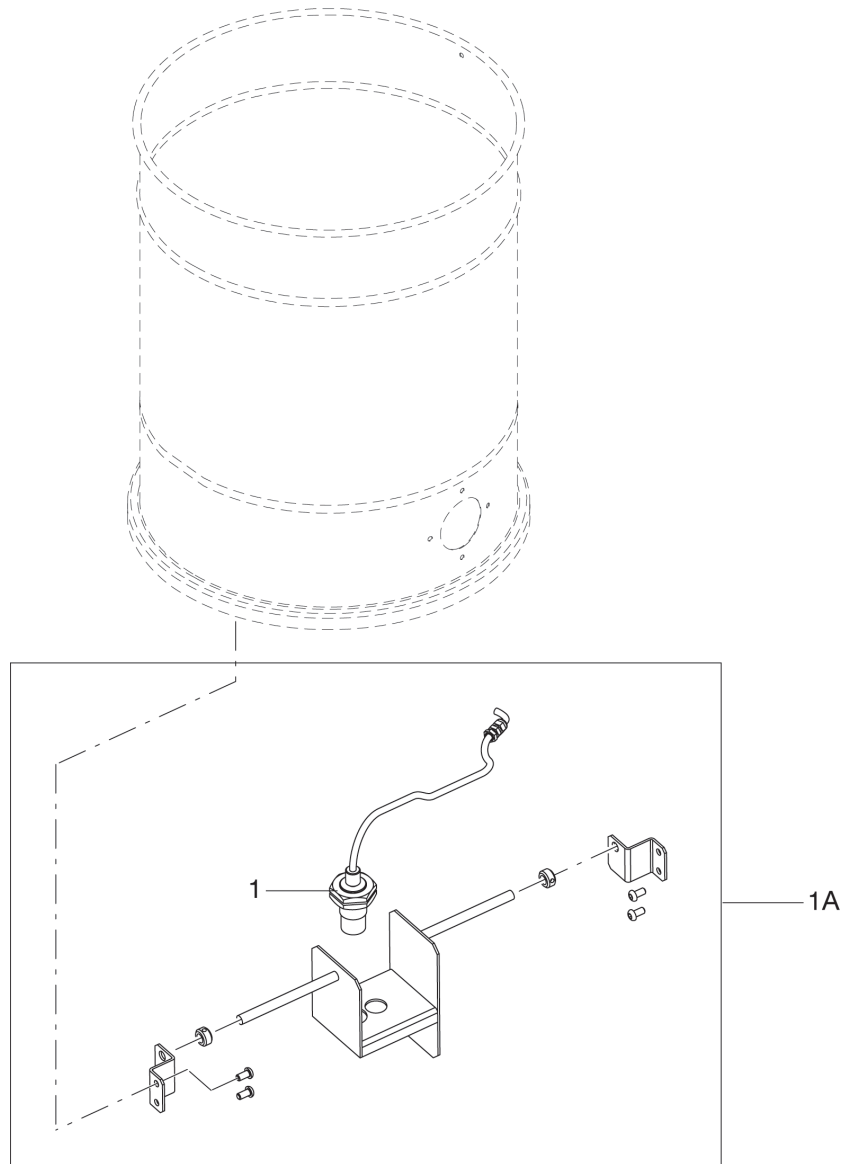

Pos.	Artikel-Nr.	Menge	Variante	Notes
1	Z58 391278	1	CAPACITIVE SENSOR M32 PA NO-NC	[1]
1A	4056000485	1	KIT STOPPING DEVICE M.S3	

Part Notes:

[1] - CONTACT PM ZOCCA

