

 **Nilfisk**<sup>®</sup>

 07351-5758060

[kontakt@nilfisk-alto-shop.com](mailto:kontakt@nilfisk-alto-shop.com)



 **Heine**  
Vertriebs-GmbH

**Preisabfrage bzw. Bestellungen der Artikel im Shop unter**

**[www.nilfisk-alto-shop.com](http://www.nilfisk-alto-shop.com)**

**einfach die Artikelnummer in die Suchmaske eingeben**

**(Bitte die Artikelnummer ohne Leerzeichen eingeben)**

# PARTS LIST



2017.02.20

# TABLE OF CONTENTS

---

Overview front .....	1
Overview back .....	3
Hose reel .....	5
Motor pump .....	7
Default accessories .....	10

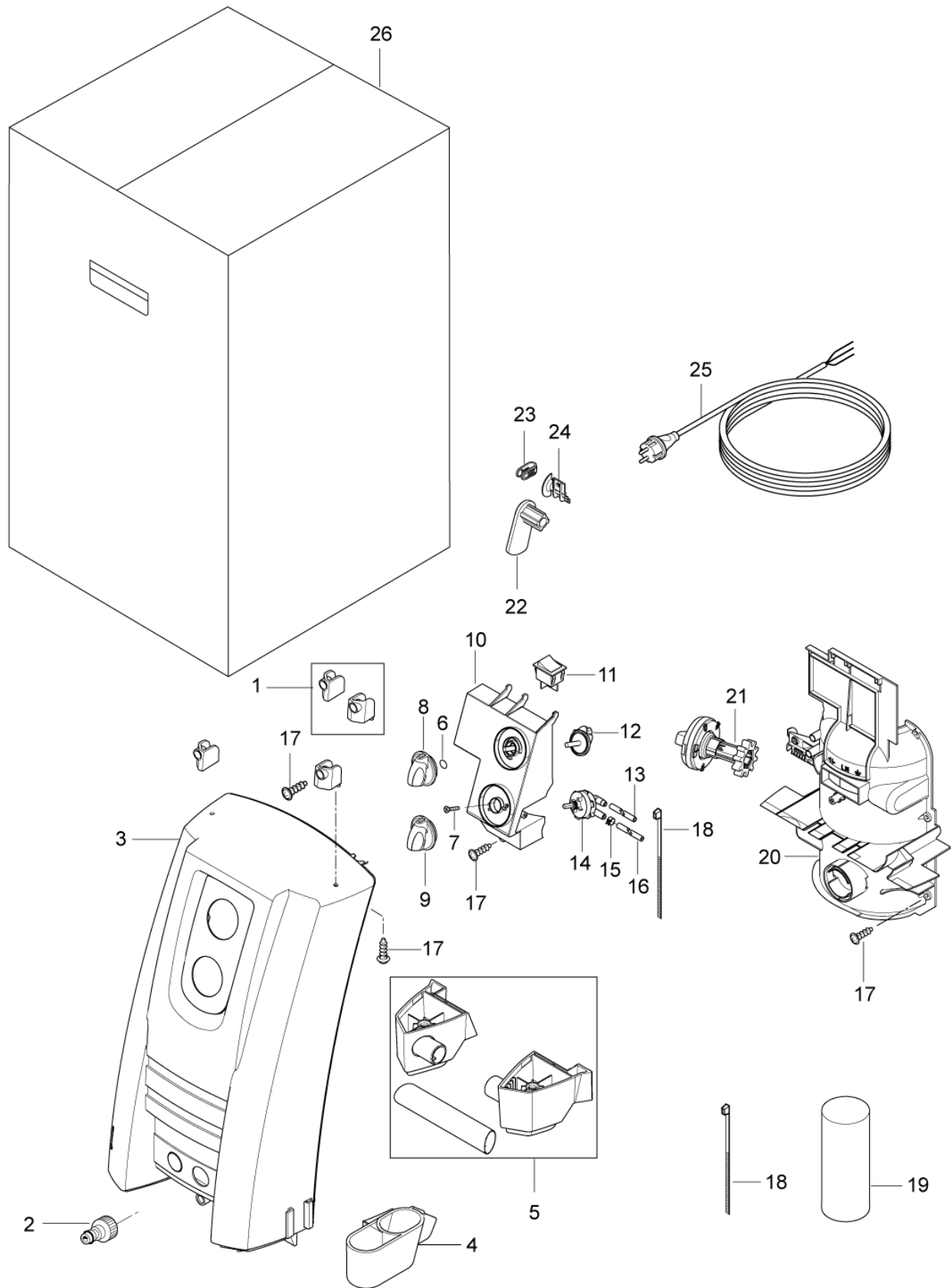

Pos.	Artikel-Nr.	Menge	Variante	Notes
1	128500146	1	Halter	
2	1402809	1	Schlauchstutzen/Nippel	
3	128500226	1	Gehäusefront	
3	128500225	1	Frontkabine POSEIDON 2 SP	
4	128500228	1	Doppelstrahlrohrhalterung	
5	128500105	1	Traggriff	
6	9868	1	O-Ring 10x2,5	
7	1814730	2	Schraube 3,5x10	
8	909100204	1	Drehknopf 6x5 blau	
9	909100214	1	Schalter GR 1 4 Kt	
10	128500109	1	Schaltergehäuse	
11	128500110	1	Schalter	[1]
12	128500108	1	Schaltnocken	[1]
13	106408241	1	Schlauch transp.2 Meter	
14	128500106	1	Dosierventil	
15	1814679	1	Schlauchschelle	
16	4973	1	Schlauch 6x3 mm x 1 m	
17	107141838	10	SCHRAUBE K50X18 WN1451 SCHWARZ TORX 20	
18	1814741	2	Kabelbinder	
19	128500154	1	Kondensator 100 µF	
19	128500148	1	Kondensator 50 µF 450 V	
20	128500111	1	Abdeckung	[1]
21	128500227	1	KNOB FLOW REGULATION BLACK	
22	128500155	1	Kabelhaken drehbar	
23	128500122	1	Kabelhalter	
24	128500121	1	Tülle	
25	128500156	1	CABLE W.PLUG L.5000 US SP	
25	128500157	1	CABLE W.PLUG L.5000 ZA SP	
25	128500123	1	Anschlussleitung Europa	
25	128500159	1	CABLE W.PLUG L.5000 JP SP	
25	128500125	1	Anschlussleitung GB	
25	128500896	1	PVC CABLE W.PLUG EU SP	
25	128500899	1	PVC CABLE W.PLUG 5000 GB SP	
25	128500900	1	PVC CABLE W.PLUG AU/NZ SP	
26	128500223	1	BOX POSEIDON2 10Stück SP	

Part Notes:

- [1] - TSB-CON-2014-001-Pro-Poseidon-On-Off-Switch-issues



Pos.	Artikel-Nr.	Menge	Variante	Notes
1	128500129	1	Rahmen	
2	128500128	2	Schiene	
3	128500119	1	Abdeckung links	
4	128500107	1	Rad. 200 mm	
5	11710	2	Klemmring 15	
6	128500118	2	Kappe	
7	6522842	1	Achse	
8	128500116	1	seitl. Abdeckung. rechts	
9	107141838	2	SCHRAUBE K50X18 WN1451 SCHWARZ TORX 20	
11	128500135	1	Platte	
12	128500130	2	Mutter M4X35 SP	
13	128500205	1	Handgriff	
14	128500132	2	Schraube M4X8 DZN7985	
15	128500133	2	Rohr	
16	128500134	2	Stopfen	
17	1814732	3	Ejotschraube KB50x18	
18	128500224	1	Doppelstrahlrohrhalterung	
19	128500144	1	Schlauchhalter	
20	128500203	2	Schraube K50x45 WN1451	
21	128500136	1	Halter	
22	128331491	1		
22	128500160	1	Zubehörhalterung	
22	128500207	1	Zubeh+rhalterung XT	
23	6520844	1	Reinigungsnadel	
24	106408241	1	Schlauch transp.2 Meter	
25	107141664	1	Deckel	
26	128500141	1	Saugkopf	
27	128500142	1	Behälter	

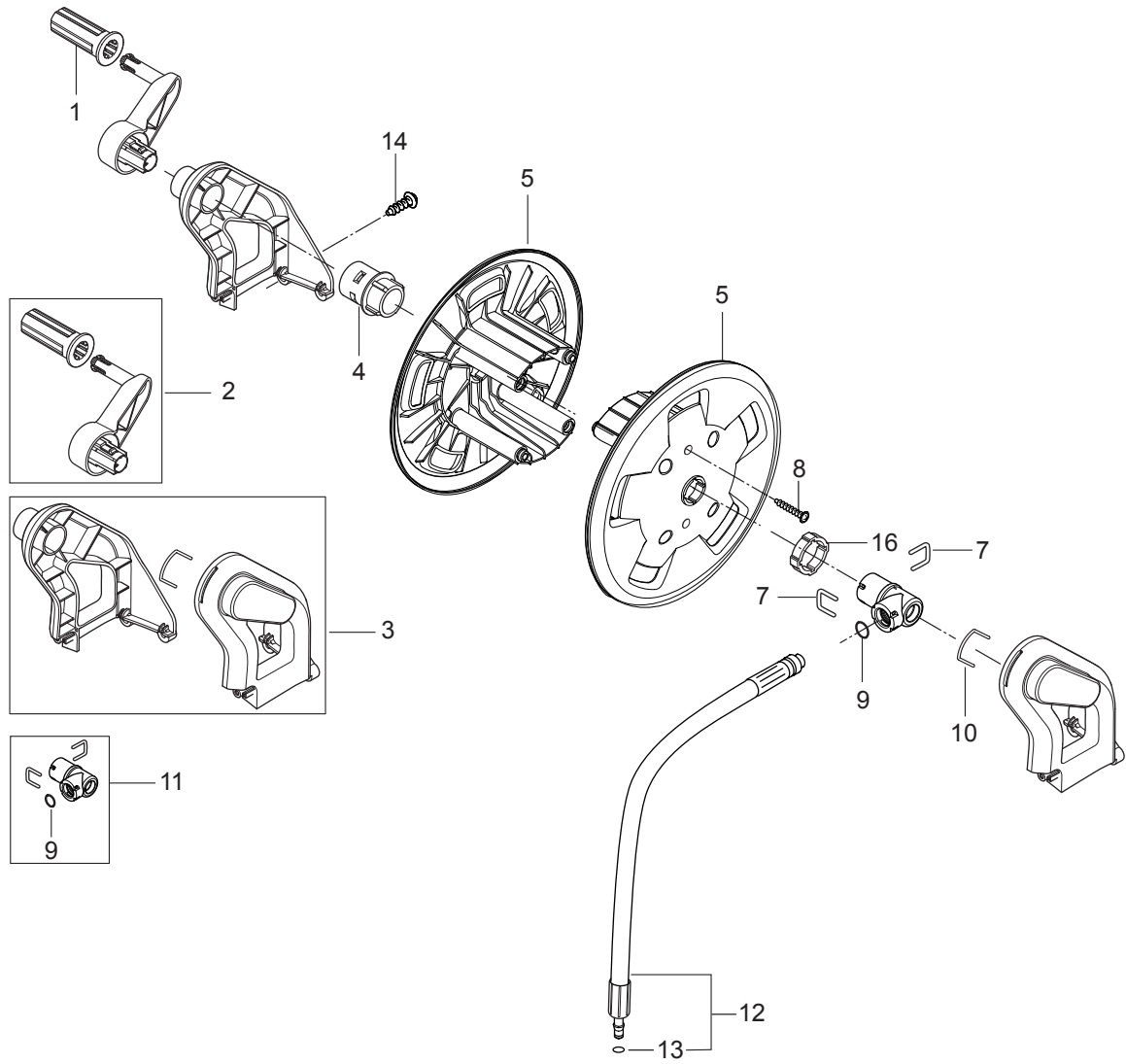



Pos.	Artikel-Nr.	Menge	Variante	Notes
1	128500750	1	HANDLE GRIB	
2	128500751	1	HANDLE FOR HOSE REEL PRO	
3	128500164	1	Führung	
4	128500869	1	AXLE FOR HOSE REEL	
5	6528570	2	Trommel	
7	6526487	2	Bügel	
8	128500595	2	SCREW K50X35 WN1452 BLACK TORX	
9	3002144	1	O-Ring 14,3 X 2,4 SMS	
10	127440229	1	Bügel	
11	127440011	1	Anschlussstück	
12	128500166	1	Hochdruckschlauch DN 6, 675 mm	
13	3004108	1	O-Ring 5,28X1,78	
14	107141838	2	SCHRAUBE K50X18 WN1451 SCHWARZ TORX 20	
16	128500167	1	Scheibe	

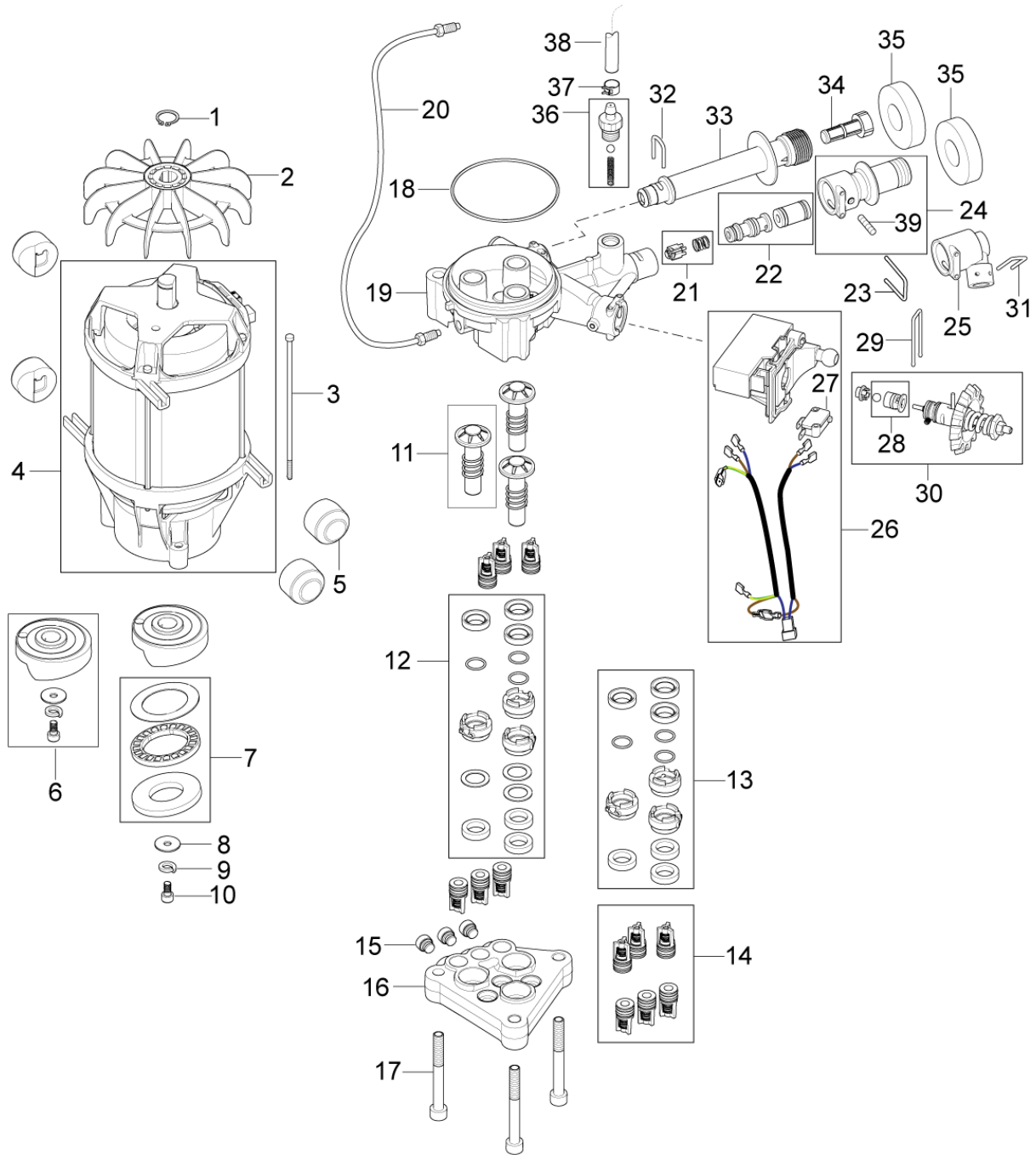

Pos.	Artikel-Nr.	Menge	Variante	Notes
1	127500051	1	Sicherungsring	
2	127500040	1	Lüfterrad	
3	7180924	4	Schraube	
4	128500169	1	Elektromotor 230 V/50 Hz	[1]
4	128500171	1	MOTOR 1.4KW 60HZ SP	[2]
4	128500168	1	Elektromotor 230 V/50 Hz	[3]
5	128332334	4	Puffer	
6	128500176	1	WOBBLE DISC 6.9 DEGREE SP	[4]
6	128500173	1	Taumelscheibe 9,5°	[5]
6	128500175	1	Taumelscheibe 8,4°	[6]
6	128500172	1	Taumelscheibe 10 grad SP	[1]
7	1119705	1	Nadellager	
8	127130066	1	Beilagsscheibe D22X6,4X1,	
9	127500050	1	Federscheibe	
10	3913	1	Zylinderschraube M6x12	
11	6526016	3	Satz Kolben	[7]
11	6528577	3	Kolben Reparatursatz	[8]
12	128500178	1	Rep. Satz	
13	128500179	1	Dichtungssatz Kolben	
14	6526026	1	Ventil	
15	6528586	3	Verschlussstopfen	
16	127440028	1	Ventilblock	[9]
16	6528616	1	Ventilblock	[10]
17	1814597	3	Zylinderschraube 8x70	
18	3003654	1	O-Ring 80,0 x 2,0 DIN	
19	128500182	1	Pumpengehäuse	
20	128500181	1	Rohr	
21	128500183	1	Rückschlagventil	
22	128500184	1	Injektor	
23	127500021	1	Bügel	
24	128500186	1	Verbindungsstück	
25	128500187	1	Verbindungsstück	
26	128500188	1	Schaltergehäuse	
27	128500196	1	Schalter	
28	128500190	1	Ventil	
29	128500191	1	Bügel	
30	128500329	1	Ventilkolben	[11]
30	128500192	1	Steuerkolben	
31	6525619	1	Bügel	
32	128500200	1	Bügel	
33	128500194	1	Verbindungsstück	
34	128500195	1	Sieb	
35	126486792	2	Dämmeinlage	
36	6528615	1	Schlauchanschluss	
37	1814679	1	Schlauchschelle	
38	4973	1	Schlauch 6x3 mm x 1 m	
39	128500242	1	Schraube M5 DIN916	

## Part Notes:

- [1] - 2-29
- [2] - 2-16 60Hz JP, 2-20 US
- [3] - 2-22, 2-25
- [4] - 2-16 60Hz JP
- [5] - 2-25
- [6] - 2-16 50Hz JP, 2-20 US, 2-22 EU, 2-29 KR
- [7] - stainless 2-25, 2-22
- [8] - ceramic 2-29
- [9] - ceramic pistons 2-29
- [10] - steel pistons 2-25

[11] - JP and US



Pos.	Artikel-Nr.	Menge	Variante	Notes
00	106403122	1	ERGO 2000 STANDARD W. HOSE SWIVEL	[1]
00	126528620	1	Schlauch, kpl., POSEIDON	[2]
00	101119496	1	Schlauchkupplung Rep.Satz	
00	6528613	1	Schlauch kpl.15m ERGO	[3]
02	106403077	1	TURBOHAMMER PLUS 950	[4]
02	106408221	1	Turbohammer Düse W12 0370	[5]
02	106402282	1	FLEXOPOWER PLUS 960	[6]
02	101119736	1	HD-Düse 0350 TORNADO	
02	106408222	1	TURBOHAMMER PLUS 1120 STR. W12 0370 KIT	[7]

## Part Notes:

- [1] - ERGO 2000 Spray handle
- [2] - Hoses - POSEIDON 2, POSEIDON 2 XT
- [3] - XT  
Hoses - POSEIDON 2, POSEIDON 2 XT
- [4] - TURBOHAMMER PLUS lance
- [5] - Poseidon 2-25XT
- [6] - FLEXOPOWER PLUS lance
- [7] - Poseidon 2-25XT  
PRUNED – NO REPLACEMENT

